



POWER ELECTRONICS®

LOW VOLTAGE

SD500•SD300•SD100

VARIABLE
SPEED DRIVES



Contents

Page 8 **Power Electronics product range**

Page 12 **SD500 Variable speed drive**

Page 14 Discovering SD500 series

Page 22 Applications

Page 24 Technical characteristics

Page 27 Standard ratings

Page 28 Accessories

Page 32 **SD300 Variable speed drive**

Page 34 Discovering SD300 series

Page 40 Applications

Page 42 Technical characteristics

Page 48 Standard ratings

Page 50 Accessories

Page 52 **SD100 Variable speed drive**

Page 54 Discovering SD100 series

Page 56 Technical characteristics

Page 57 Accessories & Standard ratings

Page 58 **Selection guide**

Page 60 **Warranty**

Page 61 **Contact**

ABOUT US

Since our inauguration in 1987 Power Electronics' strategy of continuous innovation in product development has realized an extensive range of AC variable speed drives and soft starters in low and medium voltage and utility scale solar inverters.

The expertise and know-how gained over more than 30 years in the business is demonstrated in the unique features and patented designs of our products, coupled with the shortest lead-times and unbeatable 24/7 Power On Support has consolidated Power Electronics' position as a global market leader in the AC drive and soft starter business.



INDUSTRIAL DIVISION
VARIABLE SPEED DRIVES
ELECTRONIC SOFT STARTERS

SOLAR DIVISION
SOLAR INVERTERS
SOLAR POWER STATIONS



+45
countries

Financial stability and strength

 SUSTAINABLE GROWTH

+30 years

of product
excellence and
diversification



The most complete range of
variable speed drives and soft starters

0.4kW - 6000kW

0.23kV - 13.8kV



Product and Factory independent
Reports and Certifications

— Engineered for reliability

— **3** year warranty:
Industrial products

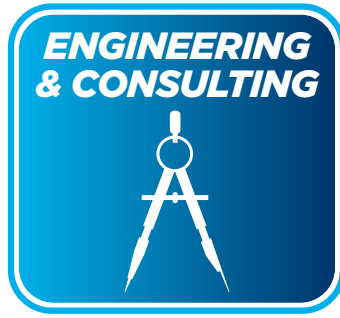

Power electronics experts

Power Electronics projects often require customer specific solutions, for this reason our clients also have our Engineering and Consulting department at their disposal, which comprise a wide number of highly skilled and experienced engineers that are available to modify our standard product to suit customer demands and ensure our clients get the product they need.

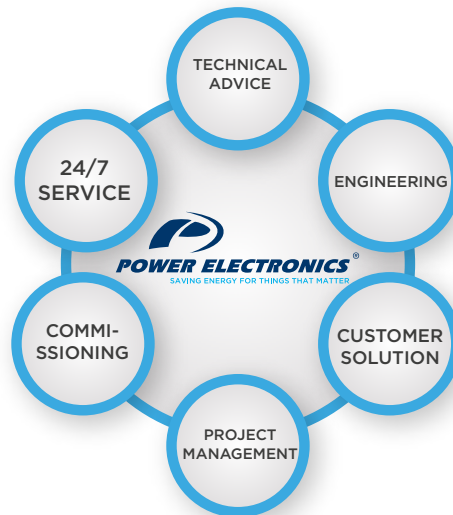



Power on Support customer oriented strategy

Power on Support is the concept of a customer oriented strategy implemented by Power Electronics since its origins more than 25 years ago with 24/7 after sales service available for all our customers and end users without the need of signing an O&M contract.

ENGINEERING SUPPORT
24/7 CUSTOMER SUPPORT
24/7 ONSITE ASSISTANCE
COMMISSIONING SUPPORT
TRAINING SEMINARS
3 YEAR WARRANTY

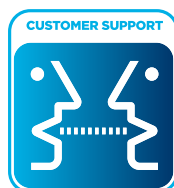



UNITED STATES

UNITED KINGDOM

SPAIN

MEXICO

PANAMA

COLOMBIA

MOROCCO

CHILE

PERU

BRAZIL

SOUTH AFRICA

power-electronics.com

in   





DISCOVER THE **POWER** **ELECTRONICS** PRODUCT RANGE





SD500

LOW
VOLTAGE
VARIABLE
SPEED
DRIVE

p. 12



SD300

LOW
VOLTAGE
VARIABLE
SPEED
DRIVE

p. 32



SD100

LOW
VOLTAGE
VARIABLE
SPEED
DRIVE

p. 52

VARIABLE SPEED DRIVES POWER RANGE

SINGLE PHASE

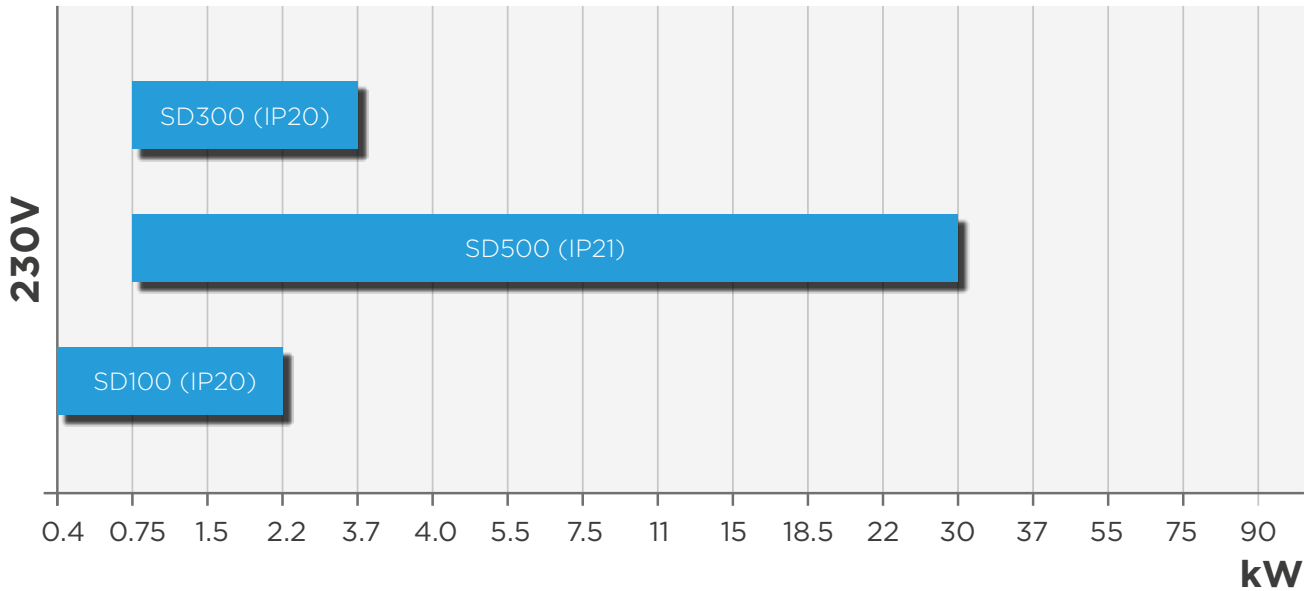

THREE-PHASE

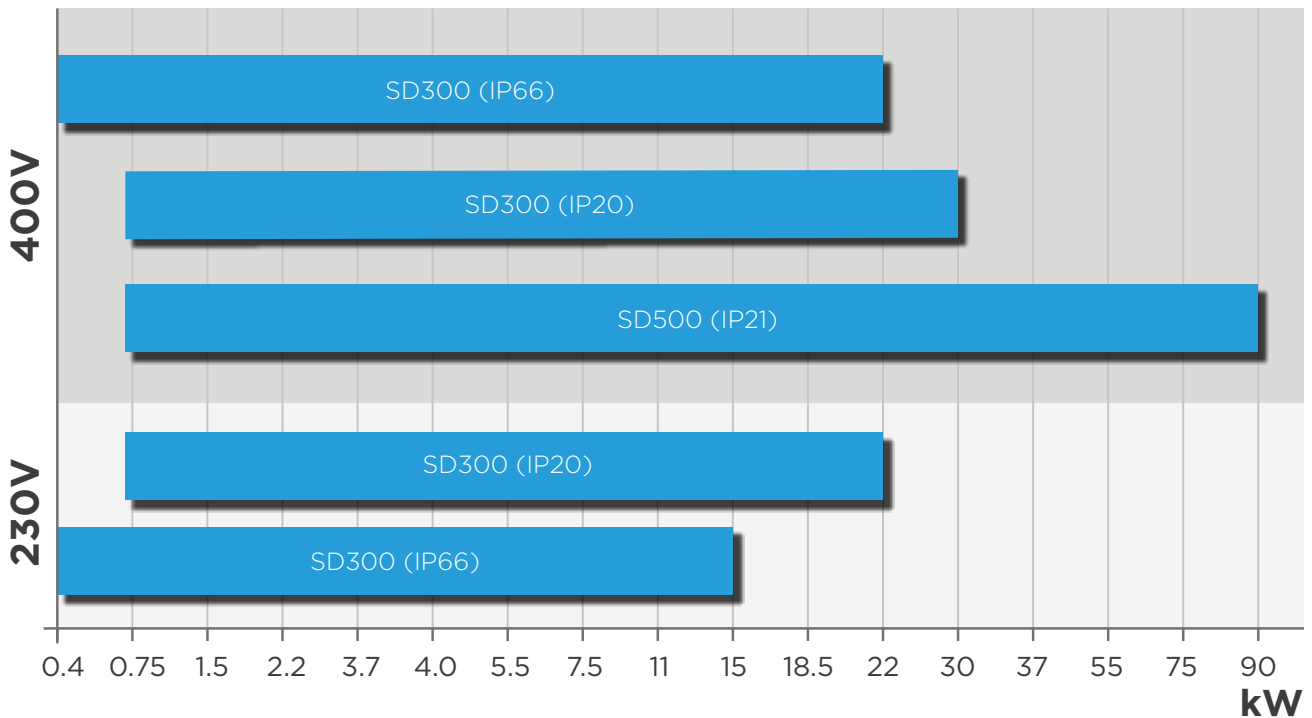

SD500

VARIABLE SPEED DRIVES



SD500

Power Electronics' experience in heavy duty industries is transferred to the lower power motor segment by offering competitive and rugged designs. The SD500 VSD covers a power range from 0.75kW to 90kW and it is available in four frame sizes that make it compatible with a wide range of applications.

Smarter and more flexible than ever, with supreme software control, the SD500 saves time and achieves superior results. The unit offers high precision and powerful control, with multiple communication protocols, maximum efficiency and motor protection. The SD500 series surpassed all expectations and is compatible with all budgets and industrial applications.

ITS MULTIPLE ACCESSORIES
GIVE SD500 THE MOST
ADVANCED FEATURES FOR
PUMP AND MOTOR CONTROL

- RANGING FROM 0.75KW TO 90KW, 200-230VAC AND 380-480VAC
- INTUITIVE CONTROL AND COMPREHENSIVE SETTING MENU
- HIGH PERFORMANCE MOTOR CONTROL
- EMC AND HARMONIC FILTERS INTEGRATED, OPTIONAL DV/DT FILTER
- RELIABLE AND ROBUST, ELECTRONICS CONFORMALLY COATED
- OPERATION TEMPERATURE OF UP TO 50°C
- MODULAR ACCESSORIES: STO, ENCODER, PLC, ETHERNET, CAN OPEN, DEVICENET, LONWORKS, I/O
- 3 YEAR WARRANTY AND 24H SERVICE AND REPLACEMENT COMMITMENT

CONFORMAL COATING

All our modules are conformally coated according to IEC61086-1: 2004,-3-1, protecting the micro components that are vulnerable to dust, moisture, pollution (PD3) and corrosive gases (3C3).

NEW MODULAR DESIGN FOR ACCESSORIES

PLC module with additional I/O, Encoder Module, Ethernet Communication Module, Safe Torque Off (STO), CanOpen, DeviceNet and Lonworks, I/O Extension Module and Dynamic Brake Unit.



EMC/RFI FILTERS
AND HARMONIC
FILTERS BUILT-IN

HIGH OVERLOAD CAPACITY

150% Overload capacity at 50°C or 110% at 40°C.



OPTIONAL dV/dt FILTER

The optional dV/dt filter 500-800V/ μ s allows installation with up to 300m of unscreened output cable.

REMOVABLE AND INTUITIVE KEYBOARD

SD500 offers the possibility to install the display up to 3m away from the drive. Install the SD500 IP54 display in the front door of the cabinet and you can safely operate the unit.

SD500 is featured with a graphic display illustrating 4 lines and 16 characters, and a membrane keypad that allows the user to move across an intuitive set of parameters that enhance programming during commissioning and maintenance tasks. Parameter reading, copying and writing functions allow a quick and easy programming of multiple units



SAFE TORQUE OFF (STO)

The STO - Safe Torque Off function allows the user to interrupt the power to the motor reliably so that it cannot generate torque. The STO module along with the installation of a safety relay and an emergency stop button saves panel space, reduces installation cost and time, increase system performance and simplifies assembly.

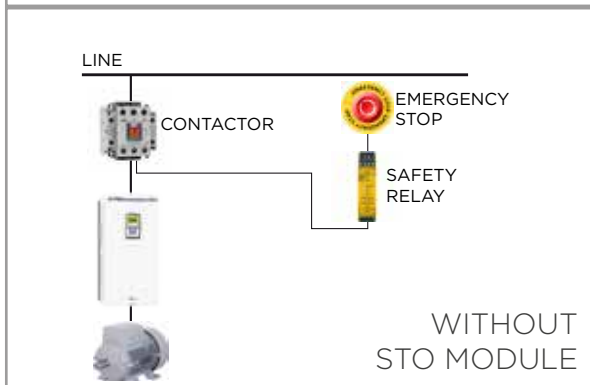

- Give access to parameters groups and subgroups.
- Pressed together increases the value or rolls up the available options.
- Pressed together decreases the value or rolls down the available options.
- Allows the user to roll up in the list of parameters.
- Allows the user to roll down in the list of parameters.
- Pressed during 3 seconds allows the user to move from one row to another. Pressed fast allows the user to escape the menu.
- Allows the user to start the motor in local control mode.
- Allows the user to stop the motor when it is running and to reset the failures.
- Allows the user to shift from local control mode to remote control mode.



One step ahead

The SD500 is best in class by offering a precise control, operation temperature up to 50°C, 150% overload capacity and built-in filters that assure you the best performance and motor lifetime.



ACCURATE, EFFICIENT AND FLEXIBLE CONTROL

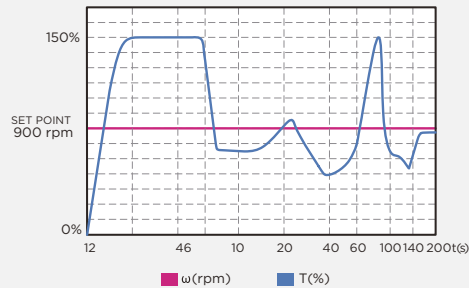

GREATER PRECISION IN TORQUE/SPEED CONTROL

The encoder module allows you to run a powerful and accurate close loop control across the whole speed range, even considering zero speed.

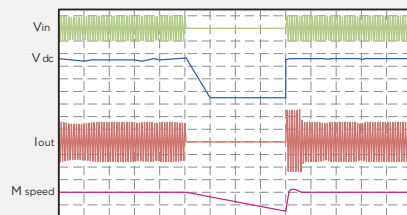

LOW VOLTAGE RIDETHROUGH FOR TEMPORALLY SHUTDOWNS

The SD500 will keep the motor and application under control under low voltage ride through events without stopping the system.

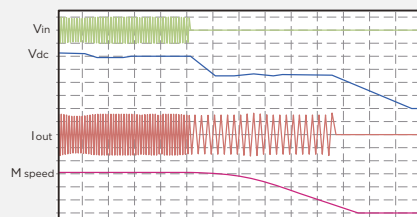

KINETIC ENERGY CONTROL

This function allows the drive to perform a controlled stop if the input power is lost.



MULTIPLE PROGRAMMABLE I/O

The drive offers as standard 2 analogue inputs, 8 digital inputs, 2 output relays and 1 digital output. Additionally, the I/O can be extended by installing the I/O module or the PLC module, and can be programmed by the PLC software. It is suitable for applications such as: pump control, irrigation scheduling, motorized valves operation...

SD500 allow the user to select the connection scheme of the digital inputs (NPN / PNP), the connection to the thermistor sensor (PTC) and the termination resistor for RS485 communications (TR).

MOTOR AND DRIVE PROTECTIONS

The SD500 provides a full set of motor and drive protections: Over-voltage, low voltage, motor thermal protection, overload and underload, phase loss, IGBT overtemperature, hardware failure, motor phase loss, external brake module failure, communications failure, reference signal loss, cooling fan failure and encoder error.

ACCURATE CONTROL,
HIGH RELIABILITY AND
MAXIMUM MOTOR CARE



DV/DT FILTERS

The optional dV/dt filters reduces the voltage peaks and common mode currents (CMC) to the motor. The SD500 dV/dt filters allows the user to install the motor with unscreened cable up to 300m or screened cable up to 150m.

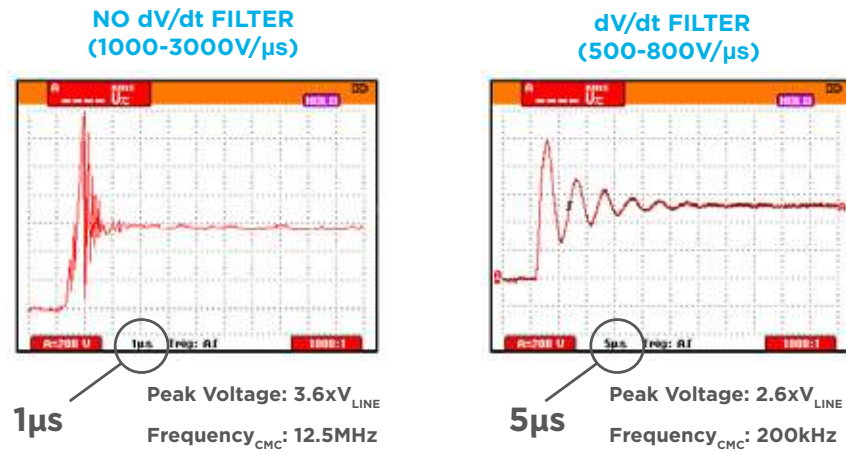

NOTE: 200m motor cable, 400V_{AC}

HARMONICS FILTERS

DC reactor built-in into the DC bus to reduce harmonics and improve the power factor.

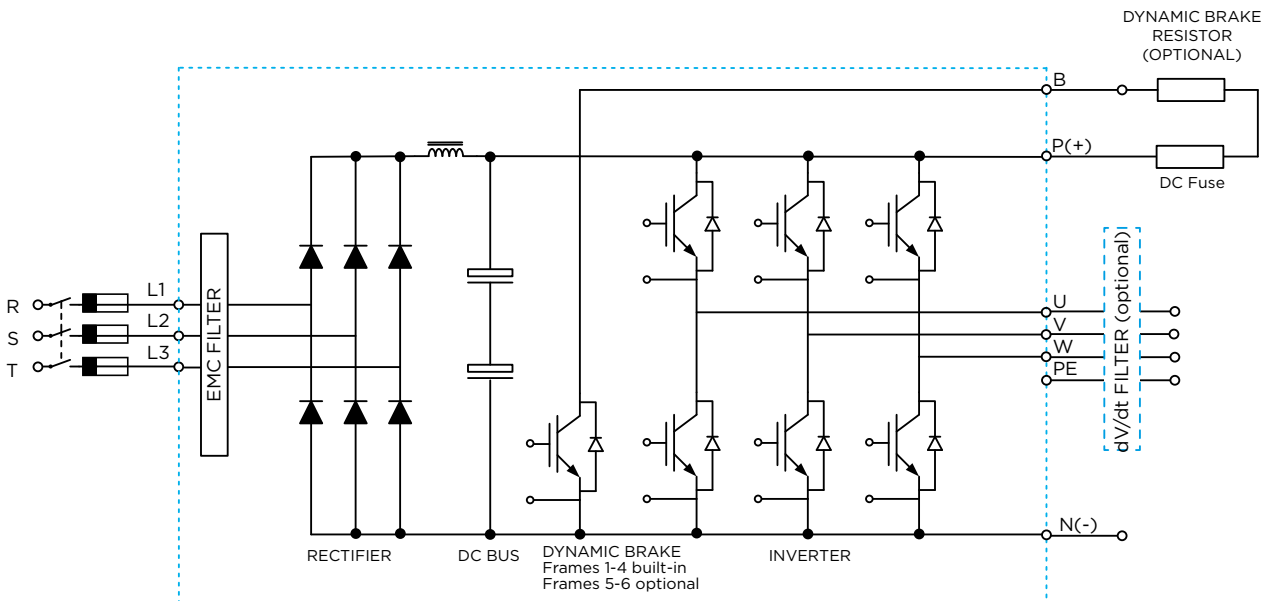

EMC/RFI FILTER

SD500 integrates built-in EMC filter Class 2 up to 22kW and Class 3 up to 90kW. For other EMC classes, optional external filters can be installed. (According to EN 61800-3).



OPERATION TEMPERATURE UP TO 50°C

Power Electronics' SD500 series can operate at temperatures up to 50°C, without derating, enabling its use inside industrial cabinets or technical rooms under hot conditions.

HEAVY 150% OR LIGHT 110% OVERLOAD

The SD500 match your application. Available with 150% overload for conveyors or mills (heavy duty) and 110% overload for pumps and fans (light duty).

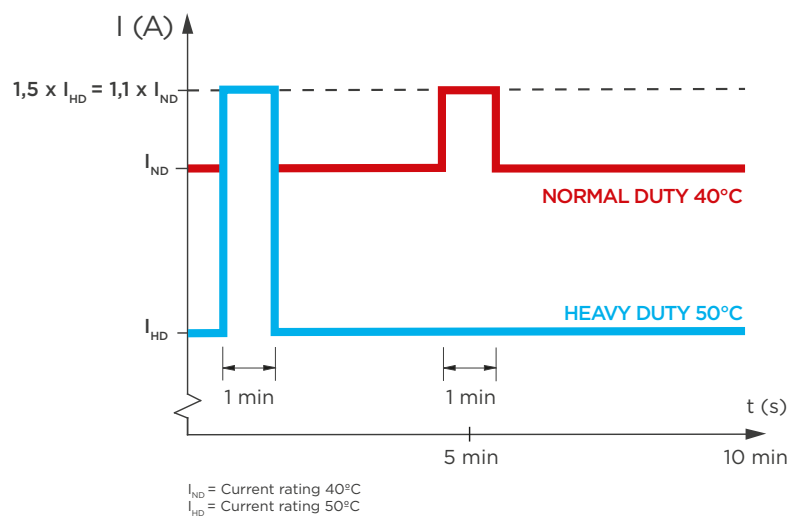

DYNAMIC BRAKE

SD500 drives offers built-in dynamic braking circuit for frames 1 to 4 and optional external braking units for frames 5 and 6. Check our accessories list for external braking resistors or external dynamic braking modules.

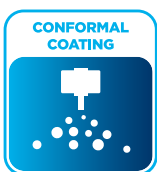

CONFORMAL COATING

The PCB coating protects the micro lead components that are vulnerable to dust, moisture, pollution (PD3) and corrosive gases 3C3 build up, which can produce conductive paths resulting in short circuiting. Power Electronics designs are dedicated to harsh environments thus PCBs modules are fully coated with the latest military and aerospace technology specifications (IEC61086-1:2004,-3-1).





Energy saving

The Variable speed drive modifies the frequency delivered to the motor adjusting the motor load speed to the instantaneous process demands. This leads to high energy savings and superior process control.



ENERGY SAVINGS

Depending on the type of load, the energy savings provided by the drive will vary significantly. The following charts describe the most common load types, their application and the relationship between the torque or power required.

QUADRATIC TORQUE APPLICATIONS

The highest savings are experienced in quadratic torque applications such as fans and centrifugal pumps. In these applications the required power is proportional to the cubic of speed following the affinity laws.

$$\frac{Q_1}{Q_2} = \frac{n_1}{n_2}$$

$$\frac{H_1}{H_2} = \left(\frac{n_1}{n_2}\right)^2$$

$$\frac{P_1}{P_2} = \left(\frac{n_1}{n_2}\right)^3$$

Q_1, Q_2 : Fluid flow at operating points 1 and 2
 H_1, H_2 : Head at operating points 1 and 2
 P_1, P_2 : Power demand at operating points 1 and 2
 n_1, n_2 : Motor speed at operating points 1 and 2

THROTTLING CONTROL

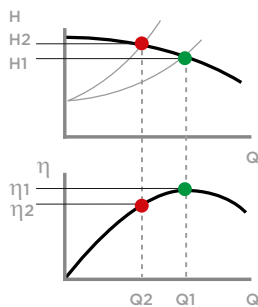

BYPASS CONTROL

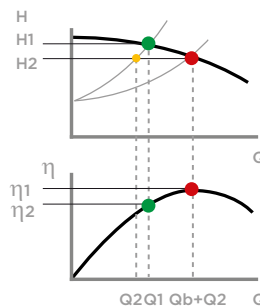

VSD CONTROL

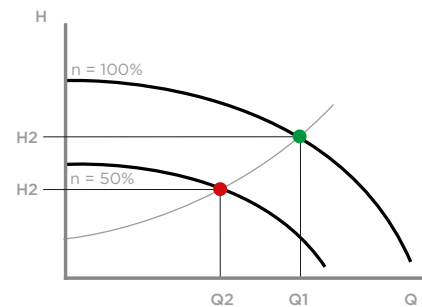

As shown in the graphs, the throttling control and bypass control modify hydraulic losses to obtain a different operation point for the desired flow. Typically they reduce the power absorbed by the motor but if the pump's hydraulic efficiency is reduced at low speed, it could be insignificant. However, variable speed drives modify the performance curve of the pump, providing higher savings and better hydraulic response.

CONSTANT TORQUE APPLICATIONS

In case of constant torque applications such as compressors or conveyors, the power demand is proportional to the speed. To illustrate that, we can focus on the example of a screw compressor regulated with a slide valve control or with a variable speed drive control.

SLIDE VALVE CONTROL

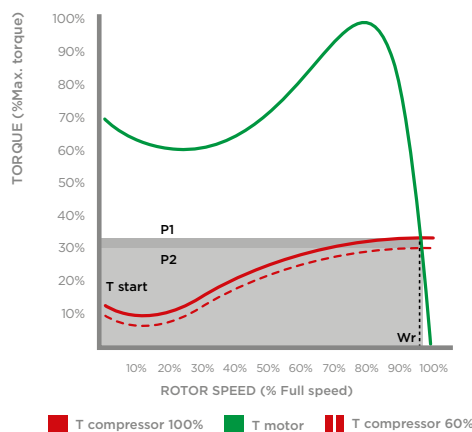

VSD CONTROL

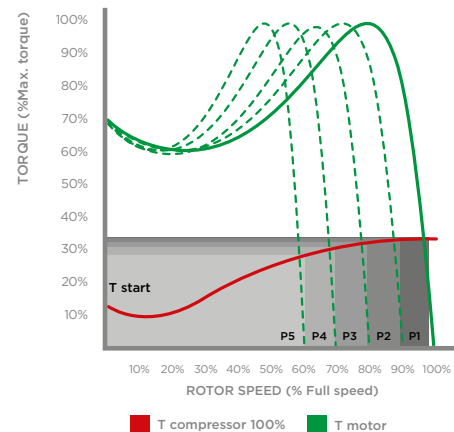

Pumping and Ventilation

As an alternative to mechanical flow control, the use of variable speed drives in variable flow systems, allows operators to dynamically change the operating range of their equipment, in order to match their flow demand, at any time. Variable speed control provides the minimum power consumption with minimum wear and tear of the hydraulic and pneumatic components.

SD500 is designed for indoor operation under the harshest environments due to its conformally coated electronics and high operating temperature range. Its design is suitable for sewage treatment plants, water treatment plants, desalination plants, pumping stations, tunnels and mines ventilating fans, etc...

SD500 offers a wide range of communication accessories and EMC filters that make it compatible with all application worldwide and eliminates the restrictions on motor cable length. The PLC module allows unlimited intelligence and provide multiple I/O that allow the user to run multi-pump systems, set irrigation schedules, set PID control by pressure, flow, level or any compatible sensor, set remote alarms, enable self-diagnostic functions, control a jockey pump, and much more thanks to intuitive programming software.



PUMPING



VENTILATION



Material handling & positioning

When accurate motion control is required, the SD500 offers the highest control features thanks to its ultimate closed loop motor control with the optional encoder module. You are able to perform a precise start, stop, back spin, spin control or shaft position control that can accelerate the production process with maximum energy savings.

By using the SD500, you not only improve the production process but you will also reduce mechanical wear and tear and the associated maintenance costs in your facility. Precise control provides better product transportation removing product damage or undesirable product spillage.

For processes that require accurate and powerful control, our variable speed drives can manage high torque with exceptional dynamic response in milliseconds.



SD500

TECHNICAL CHARACTERISTICS

INPUT	Power range	0,75kW - 90kW	
	Voltage power	200-230Vac (-15% a +10%), 380-480Vac Three phase (-15% a +10%)	
	Input frequency	50-60 Hz \pm 5%	
	Power factor (cos ϕ)	>96%	
	Input EMC/RFI Filter	0,75 to 22kW - C2 standard / 30kW or more - C3 standard ^[1]	
	Input rectifier technology	Diode	
	Harmonics filter	DC Reactance	
	Current THDi (%)	<37%	
OUTPUT	Overload capacity	Constant torque: 150% during 60 sec at 50°C Variable torque: 110% during 60 sec at 40°C	
	Output frequency	0 to 400Hz ^[2]	
	Resolution of frequency set	Operation with digital signals: 0.01Hz Operation with analogue signals: 0.06Hz (Maximum frequency: 60Hz)	
	Modulation frequency	Maximum 15kHz ^[3]	
	Control Method	V/F Control, Slip compensation, Open Loop Vector Control (sensorless), Closed Loop Vector Control Lineal V/F, Quadratic, defined by the user	
	Output cable length	USC 50m ^[4] SC 25m	
	Optional dv/dt filter	500-800V/ μ s - USC 300m, SC 150m	
	Dynamic brake	Built-in frames 1 to 4. Optionl frames 5 and 6	
ENVIRONMENTAL CONDITIONS	Degree of protection	IP21, Display IP54	
	Operation temperature	Minimum -10°C, Maximum +50°C	
	Storage temperature	Minimum -20°C, Maximum +70°C	
	Relative humidity	<90%, non-condensing	
	Altitude	1000m	
	Power altitude derating (> 1000m)	1% per 100m; maximum 3000m	
	Vibration	5,9m/sec ² (=0,6G)	
	Ventilation	Air forced refrigeration	
PROTECTIONS	Overvoltage	Low Voltage	Overcurrent
	Overcurrent detection	Overtemperature of the inverter	Motor thermal Protection
	Phase loss protection	Overload Protection	Communication Error
	Reference Signal Loss	Hardware Failure	Cooling Fan Fault
	Pre-PID failure	Absence of motor Trip	External brake failure
	Current Limitation	Overload	Underload
	Encoder failure	Fan failure	Loss of keyboard commands
	Loss of speed commands		
INPUTS /OUTPUTS	Analogue inputs	1 input 0-10Vdc, \pm 10Vdc / 1 input 4-20mA / 0-20mA	
	Digital inputs	8 configurable inputs	
	PTC connection	Yes. With analogue or digital specific setup for PTC	
	Analogue outputs	1 0-10V output (Max. Output Voltage 10V, Max. Output Current 10mA) 1 0-20mA / 4-20mA output (Max. Output Current 20mA)	
	Relay output	1 Changeover programmable relay (250VAC, 5A; 30VDC, 5A) 1 Programmable normally open relay (250VAC, 5A; 30VDC,5A) 1 Programmable open collector transistor output (24VDC, 50mA)	
	I/O Extension module (optional)	3 digital outputs NO (250Vac/30Vdc, 5A), 3 digital inputs (selection of PNP/NPN, 0-25V), 1 voltage analogue input, 1 current analogue input (0-20mA) Internal Impedance: 249 Ω , 1 voltage analogue output (\pm 10V, 10mA, 11 bits resolution), 1 current analogue output (0-20mA, 12 bits resolution)	
	PLC module	6 digital configurable inputs, 4 realy outputs expandable to 14	
	STO module	2 inputs (24Vdc, Max. 10mA), 1 input (24Vdc), Feedback terminals	
Encoder module	Liner driver or open collector, pulse train reference. 5/12/15V Isolated power supply		
COMMUNICATION	Standard Hardware	RS485 port	
	Standard Protocol	Modbus-RTU	
	Optional Hardware	Profibus-DP board, Ethernet board, LonWorks board, DeviceNet/CANopen board	
	Optional Protocols	Profibus, Modbus TCP, LonWorks, CANopen, DeviceNet	

CONTROL	Alphanumeric display	4 Lines of 16 characters. Arrows to adjust parameters. Independent memory.
	Removable	Optional 1 m, 2m y 3m
	Connection	RJ45
	Status leds	LED ON: Power on the control board LED RUN: Power on, the motor is powered by the SD500 LED FAULT: Flashing indicates the equipment is in fault
	Display information	Status, DC Bus voltage, Motor current, Motor frequency, Motor speed, Motor voltage, Torque, Temperature, Input/output, Signals status, PID reference, Number of pumps
REGULATIONS	CE, cTick, UL ^[5] , cUL ^[5]	

- NOTES [1] For other application categories, an optional external filter will be used. For additional information ask Power Electronics.
 [2] The maximum frequency is 300Hz when selecting the open loop control in the programming parameters.
 [3] The maximum allowable depends directly on the power of the drive. Consult the SD500 Software and Programming manual for additional information.
 [4] Motors with reinforced insulation withstand greater cable lengths. Consult Power Electronics.
 [5] On process.

SD500 - WIRING CONTROLS

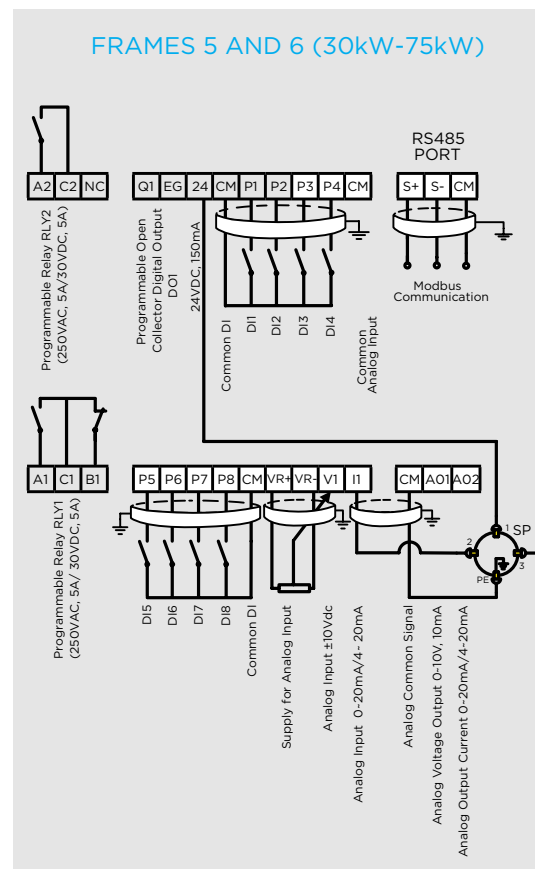
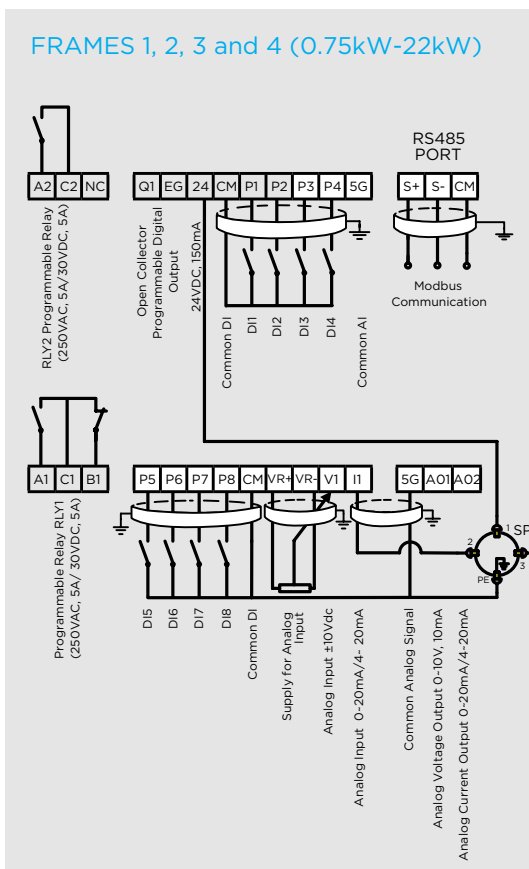

NOTE Control cables must be shielded and grounded.

SD500 - CONFIGURATION TABLE

SD5	O16		2		2	
SD500 series	Output current ^[1]		Rated Voltage		Protection degree	
SD5	002	2A	2	200-230V	2	IP21
	005	5A	4	380-480V		
				
	150	150A				

[1] Verify the rated current of the motor nameplate to guarantee the compatibility with the selected drive.

SD500 - DIMENSIONS (mm) AND WEIGHTS (kg)

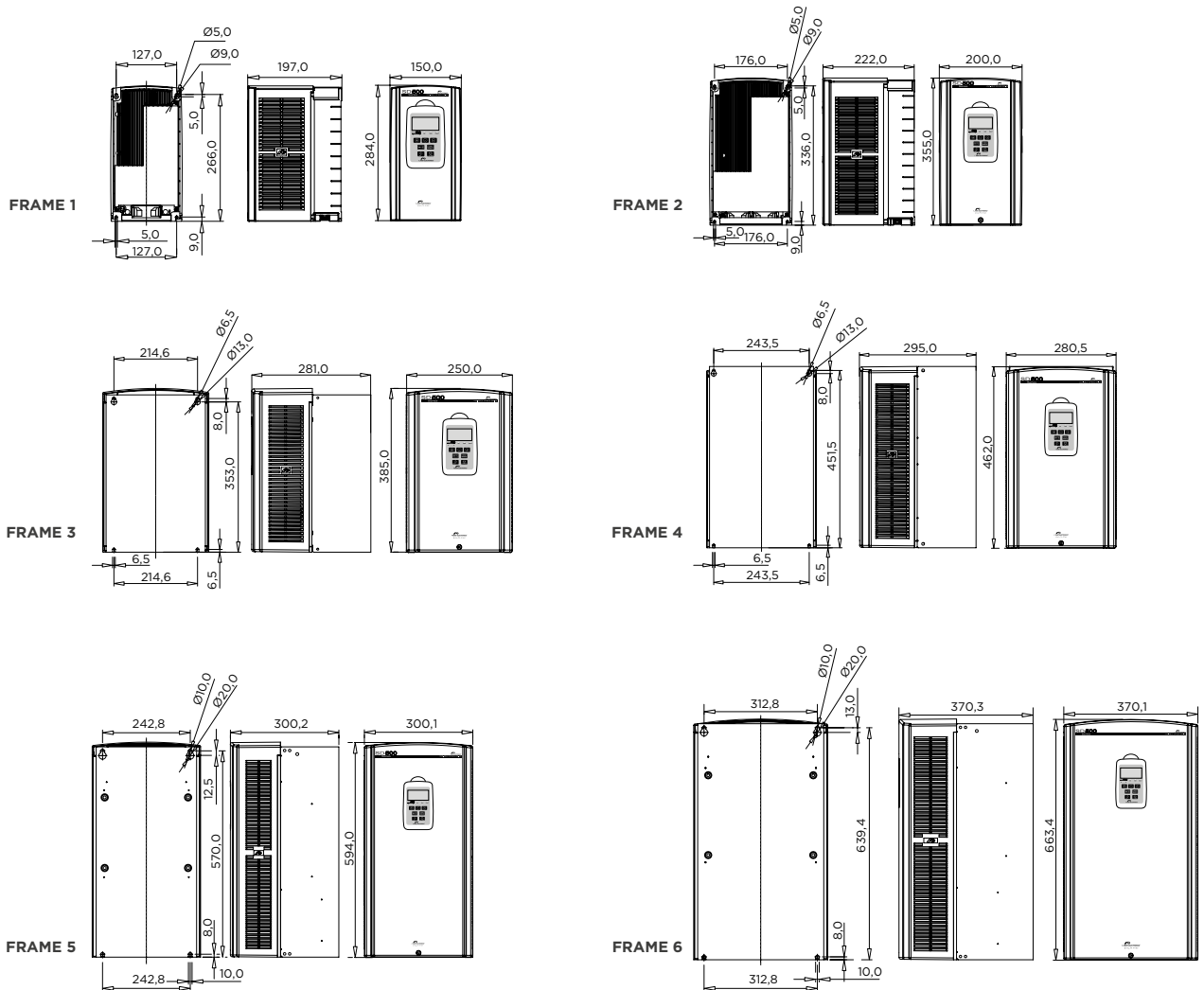

Frame	1	2	3	4	5	6
Weight (kg)	5.5	10	20	30	41	63

SD500 - STANDARD RATINGS

200Vac - 230Vac (-15% a +10%)									
FRAME	CODE	Operation temperature 50°C HEAVY DUTY				Operation temperature 40°C NORMAL DUTY			
		I(A) Rated	Motor Power 230Vac		150% Overload (60s)	I(A) Rated	Motor Power 230Vac		110% Overload (60s)
			kW	HP			kW	HP	
1	SD5005 2 2	5	0.75	1	7.5	6.8	1.5	2	7.5
	SD5008 2 2	8	1.5	2	12	11	2.2	3	12
	SD5012 2 2	12	2.2	3	18	16	3.7	5	18
	SD5016 2 2	16	3.7	5	24	22	5.5	7.5	24
2	SD5024 2 2	24	5.5	7.5	36	33	7.5	10	36
	SD5030 2 2	32	7.5	10	48	44	11	15	48
3	SD5045 2 2	46	11	15	69	60	15	20	69
	SD5060 2 2	60	15	20	90	74	18.5	25	90
4	SD5075 2 2	74	18.5	25	111	90	22	30	111
	SD5090 2 2	88	22	30	132	120	30	40	132

380Vac - 480Vac (-15% a +10%)									
FRAME	CODE	Operation temperature 50°C HEAVY DUTY				Operation temperature 40°C NORMAL DUTY			
		I(A) Rated	Motor Power 400Vac		150% Overload (60s)	I(A) Rated	Motor Power 400Vac		110% Overload (60s)
			kW	HP			kW	HP	
1	SD5002 4 2	2.8	0.75	1	4.4	4	1.5	2	4.4
	SD5004 4 2	4	1.5	2	6	5.4	2.2	3	6
	SD5006 4 2	6	2.2	3	9	8	3.7	5	9
	SD5008 4 2	8.5	3.7	5	13.2	12	5.5	7.5	13.2
2	SD5012 4 2	12	5.5	7.5	18	16	7.5	10	18
	SD5018 4 2	16.5	7.5	10	25	23	11	15	25
3	SD5024 4 2	24	11	15	36	32	15	20	36
	SD5030 4 2	30	15	20	45	40	18.5	25	45
4	SD5039 4 2	39	18.5	25	58	48	22	30	58
	SD5045 4 2	45	22	30	67	61	30	40	67
5	SD5060 4 2	61	30	40	91	78	37	50	91
	SD5075 4 2	75	37	50	112	100	45	60	112
	SD5090 4 2	91	45	60	136	115	55	75	136
6	SD5110 4 2	110	55	75	165	150	75	100	165
	SD5150 4 2	152	75	100	228	180	90	125	228

NOTES Rated power for standard AC 4 pole motors (1500rpm).
For other configurations contact Power Electronics.
Check the rated current of the motor plate to ensure compatibility with the chosen frequency converter.

SD500

ACCESSORIES

dV/dt FILTERS

INPUT	Voltage power	200Vac-480Vac
	dV/dt value	500V/ μ s - 800V/ μ s
	Overload capacity	150% 60 sec
	Ventilation power supply	Frames 1 and 2, no ventilation. Frames 3, 4, 5 y 6, 230Vca Max. 18W
ENVIRONMENTAL CONDITIONS	Temperature	-10°C to +50°C
	Degree of protection	IP20
	Class of protection	Class I
	Relative humidity	<90%, non-condensing

230Vac (-15% a +10%)			
FRAME	VSD	dV/dt FILTER	TOTAL HEIGHT (mm)
1	SD500522	SD50F0522	412
	SD500822	SD50F0822	
	SD501222	SD50F1222	
	SD501622	SD50F1622	
2	SD502422	SD50F2422	495
	SD503022	SD50F3022	
3	SD504522	SD50F4522	511
	SD506022	SD50F6022	
4	SD507522	SD50F7522	625
	SD509022	SD50F9022	

380Vac - 480Vac (-15% a +10%)			
FRAME	VSD	dV/dt FILTER	TOTAL HEIGHT (mm)
1	SD500242	SD50F0024	412
	SD500442	SD50F0044	
	SD500642	SD50F0064	
	SD500842	SD50F0084	
2	SD501242	SD50F0124	495
	SD501842	SD50F0184	
3	SD502442	SD50F0244	511
	SD503042	SD50F0304	
4	SD503942	SD50F0394	625
	SD504542	SD50F0454	
5	SD506042	SD50F0604	819
	SD507542	SD50F0754	
	SD509042	SD50F0904	
6	SD511042	SD50F1104	896.4
	SD515042	SD50F1504	



CONNECTIONS BOX

FRAME	FILTER				
	REFERENCE	DIMENSIONS			
		W	D	H	Total height
1	SD5EB1	147	85	132	416
2	SD5EB2	195	100	145	500
3	SD5EB3	250	165	135	520
4	SD5EB4	280	205	135	597
5	SD5EB5	300	205	130	724
6	SD5EB6	370	205	138	801

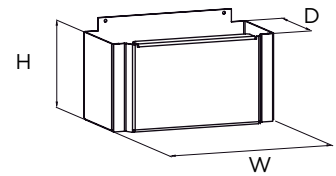

DYNAMIC BRAKE UNIT

380-480Vac - FRAMES 5 and 6		
VSD	DBU	DIMENSIONS (WxDxH)
SD506042,SD507542	DBSD4075	123x130x258
SD509042, SD511042	DBSD4145	
SD515042		



DISPLAY EXTENSION KIT

CODE	ACCESSORIES DESCRIPTION
SD5RC2	Display extender kit (2 meters)
SD5RC3	Display extender kit (3 meters)

CODE	ACCESSORIES DESCRIPTION
SD5IO	Extension module Input/Output
SD5EC	Encoder module
SD5PLC	PLC module
SD5ET	Ethernet communication module
SD5DN	DeviceNet communication module
SD5DP	Profibus - DP communication module
SD5CO	CANopen communication module
SD5LW	Lonworks communication module
SD5STO1	STO module. Safe Torque Off frame 1
SD5STO2	STO module. Safe Torque Off frame 2 and 3
SD5STO3	STO module. Safe Torque Off frame 4, 5 and 6



STO - SAFE TORQUE OFF

STO - Safe Torque Off board allows to stop supplying alternating power to the stator stopping the motor by its own inertia.

- 2 inputs (24Vdc, max. 10mA)
- 1 input (24Vdc)
- Feedback terminals
- VIEC/EN G1800-5-2
- Safety level SIL2



EXTENSION MODULE INPUT/OUTPUT

Extension module allows increase standard analogics I/O, multiplying their benefits of multipump applications:

- 3 digital outputs NO (250Vac/30Vdc, 5A)
- 3 digital inputs (selection of PNP/NPN, 0-25V)
- 1 voltage analogue input
- 1 current analogue input (0-20mA) Internal Impedance: 249Ω
- 1 voltage analogue output (±10V, 10mA, 11 bits resolution)
- 1 current analogue output (0-20mA, 12 bits resolution)
- Scan time:
 - Digital outputs: 1.5ms minimum
 - Analogue output: Minimum 3ms
- Protection: IP20
- Cooling method: Self cooled



ENCODER MODULE

Encoder module allows closed loop control for applications that request:

- Closed loop control
- Pulse train reference
- 5/12/15V insulated power supply
- Line driver open collector
- 200kHz Maximum input frequency
- Signal loss detection



PLC MODULE

PLC module allows programming and expansion of digital and analogical inputs and outputs.

- Operation method:
 - Stored program cyclic operation
 - Role of Task Interruption
- Method of I/O control:
 - Number of instructions: Basic: 29; Rev: 223
 - Processor time: Basic instruction: 0.4µs/operation
 - Program memory capacity: 2k
 - 6 digital inputs
 - 4 relay outputs
 - Operating modes: RUN, STOP, PAUSE
- Self-diagnosis Functions: Watchdog timer, memory error detection, I/O error detection
- Recovery of memory after shutdown
- PID Control
- RS485 Communication: MODBUS protocol support
- External interrupts: 6
- Input filter: 0 - 1000ms
- RTC (Real Time Clock): year / month / day / hour / minute / second using KGLWIN
- Operating system KGL WIN

COMMUNICATION MODULES

Ethernet, Devicenet, Profibus, CANopen and Lonworks communication modules allow the user to easily integrate the SD500 in multiple networks.



ETHERNET IP / MODBUS-TCP COMMUNICATION MODULE

- Transmission Speed: 10Mbps, 100Mbps
- Transmission Method: Baseband
- Maximum distance between nodes: 100m
- Maximum number of nodes: Hub Connection
- Auto negotiation
- Maximum frame size: 1500 bytes
- Access Method to communications area: CSMA / CD
- Checking Method for error frames: CRC32
- Recommended Channel Connection: 3 channels



DEVICENET COMMUNICATION MODULE

- Power supply:
 - Powered from the drive
 - External power supply: 11-25VDC, 60mA
- Network topology: Free, Bus
- Transmission speed: 125kbps, 250kbps, 500kbps
- Maximum number of nodes: 64 (including the master)
- Supported media type: Explicit Peer to Peer Messaging
- Faulted Node Recovery (Off-Line), Master / Scanner, Polling
- Terminating resistor: 120Ω 1/4W Lead Type



PROFIBUS COMMUNICATION MODULE

- Device Type: Profibus DP Slave
- Auto baud rate
- Sync mode
- Freeze mode
- Maximum input length: 8 words
- Maximum output length: 8 words
- Maximum data length: 16 words
- Transmission speeds: 9.6K, 19.2K, 93.75K, 187.5K, 500K, 1.5M, 3M, 6M, 12M
- Modular station
- Maximum number of modules: 2



CANOPEN COMMUNICATION MODULE

- Power supply: Supplied from the inverter
- Network Topology: Bus
- Baud rate: 20kbps, 50kbps, 100kbps, 125kbps, 250kbps, 500kbps, 800kbps, 1Mbps
- Maximum number of nodes: 64 (including the master)
- Supported media type: PDO, SDO, Sync, NMT
- Terminating resistor: 120Ω 1/2W Lead Type
- PDO available: PDO1 (CiA 402 Drive control and Motion device profile)
- Maximum Transmission Distance: 2500m (20kbps) - 500m (125kbps)



LONWORKS COMMUNICATION MODULE

- 78kbps communication speed
- Free/bus topology
- Resistance built-in per topology
- Max. 2700m (8858ft) connection distance (bus topology)

SD300

VARIABLE SPEED DRIVE

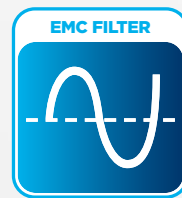

SD300

The SD300 is a high performance general purpose AC drive that excels in demanding heavy-duty applications that require high starting torque and precise control. The dual duty rating of the IP20 models ensures compatibility with all normal duty loads. The IP66/NEMA4X models guarantee operation even in the most severe environments.

The versatile SD300 is ideal for applications in water treatment and irrigation, food and beverage, ventilation systems, materials handling, packaging systems, textiles, plastic, wood processing, in fact any general purpose application where apparatus and machinery needs to be automated.

EXCEPTIONAL PERFORMANCE
IN ANY APPLICATION

- SENSORLESS VECTOR CONTROL WITH 200% STARTING TORQUE
- SIDE-BY-SIDE MOUNTING
- COMPACT FOOTPRINT
- MULTIPLE FIELDBUS OPTIONS
- BUILT-IN EMC FILTER AND COMPLIANT WITH INTERNATIONAL STANDARDS
- BUILT-IN SAFE TORQUE OFF (STO) AND REDUNDANT INPUT CIRCUIT
- IP66 MODELS

SD300 MAIN FEATURES

- The SD300 AC drive is an easy-to-use, compact and robust product offering users savings in time and space.
- The overall motor control features and the motor/drive protection functions limit unexpected machine downtime.
- An integrated keypad offers programming and operation capabilities.
- Integrated communication port and Modbus protocol allows the SD300 to exchange data for machine/process monitoring, control and preventive maintenance.

- 0.4kW to 2.2kW 230V SPh
- 0.4kW to 22kW 230V 3Ph.
- 0.4kW to 30kW 400V 3Ph.

I/O expansion card option:

- 2 Relay Outputs
- 3 Digital inputs
- 2 Analog Inputs
- 1 Analog Output

Powerful sensorless control.
High torque at very low speed
(200% at 0,5 Hz)

50°C operating temperature.
Suitable for IT Power Networks.

IP20 and IP66 degree of
environmental protection.

Built in display with keypad.
Remote LCD display option.

Output frequency up to 400Hz,
Sensorless and V/Hz motor
control, 150% current overload
capability.

Safe Torque Off (STO) as standard.
Meets EN ISO 13849-1 PLd and EN
61508 SIL2 (EN60204-1, stop category
0).

Intuitive control and
comprehensive menu setup
including PID, PLC functionality.

Integrated EMC filter compliant with
EN61800-3 and EN 61800-5-1.

CE marked, UL/cUL listed & RCM
(Australia & New Zealand) certified.

Multiple fieldbus options: Profibus,
Profinet, Ethercat, Ethernet I/P,
Modbus TCP.

RS485 communication port with
integrated Modbus protocol as
standard

BIG ON PERFORMANCE SMALL ON SPACE

- SPACE SAVING DESIGN WITH SIDE BY SIDE MOUNTING
- BUILT-IN RFI FILTER ON SINGLE PHASE AND THREE PHASES
- JUMPER TO DISCONNECT RFI FILTER (IT POWER NETWORKS)
- INTEGRATED BRAKE CHOPPER
- POWER, DC BUS AND GROUND TERMINALS
- SAFE TORQUE OFF (STO) AS STANDARD
- MULTIPLE FIELDBUS OPTIONS
- FAST A/D CONVERSION, TORQUE COMPENSATION AND SMOOTH CONTROL AT LOW SPEED
- IP66 WITH DISCONNECT SWITCH



CONTROL I/O TERMINAL BLOCK

- 7 Digital inputs (5 on IP66 option).
- Analog input configurable V/mA.
- Analog input 0-10V.
- Output Relay.
- Digital Output Open Collector.
- I/O Expansion Card Option.

BUILT IN KEYPAD WITH DISPLAY

- 4 Digits display for Parameter, Frequency, Voltage, Current, Temperature, Fault messages.
- Multi function LEDs.
- Parameter navigation keys: Up, Down, Left and Right.
- Run, Stop/Reset keys.



THE DRIVE FOR HARSH ENVIRONMENTS

Protected against fine dust and high pressure water jets.

- Meets IEC 60529 standard IP66
- Meets NEMA 4X for indoor use
- 200/400V 0.4-22kW
- Integrated Disconnect Switch

SAFETY FUNCTIONS

SAFE TORQUE OFF

The Safe Torque Off function meets EN ISO 13849-1 PLd and EN 61508 SIL2 (EN60204-1, stop category 0).

This feature is standard and enables compliance with current safety standards.

REDUNDANT INPUT CIRCUIT

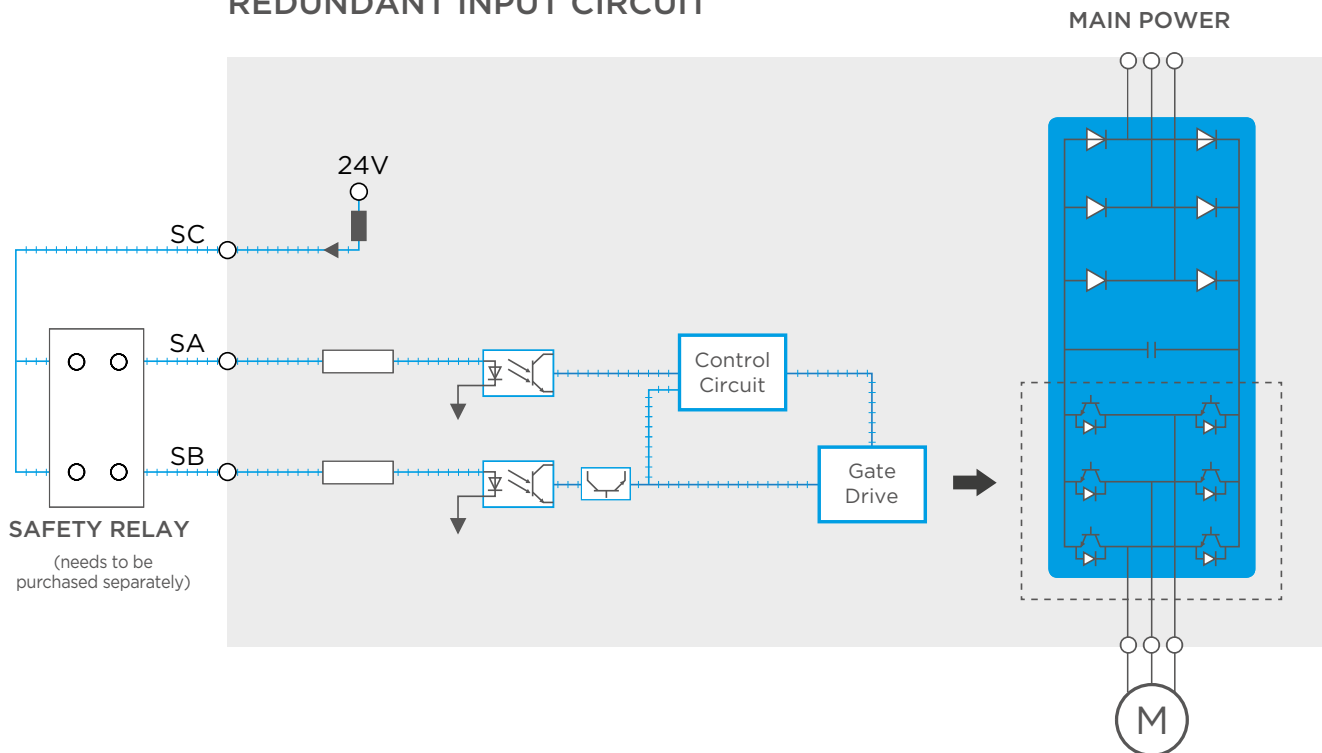

GLOBAL STANDARDS

The SD300 AC drive complies with all the major international standards.





- CE, UL, cUL, RoHS.
- 3C2 Conformal coating on PCBs.

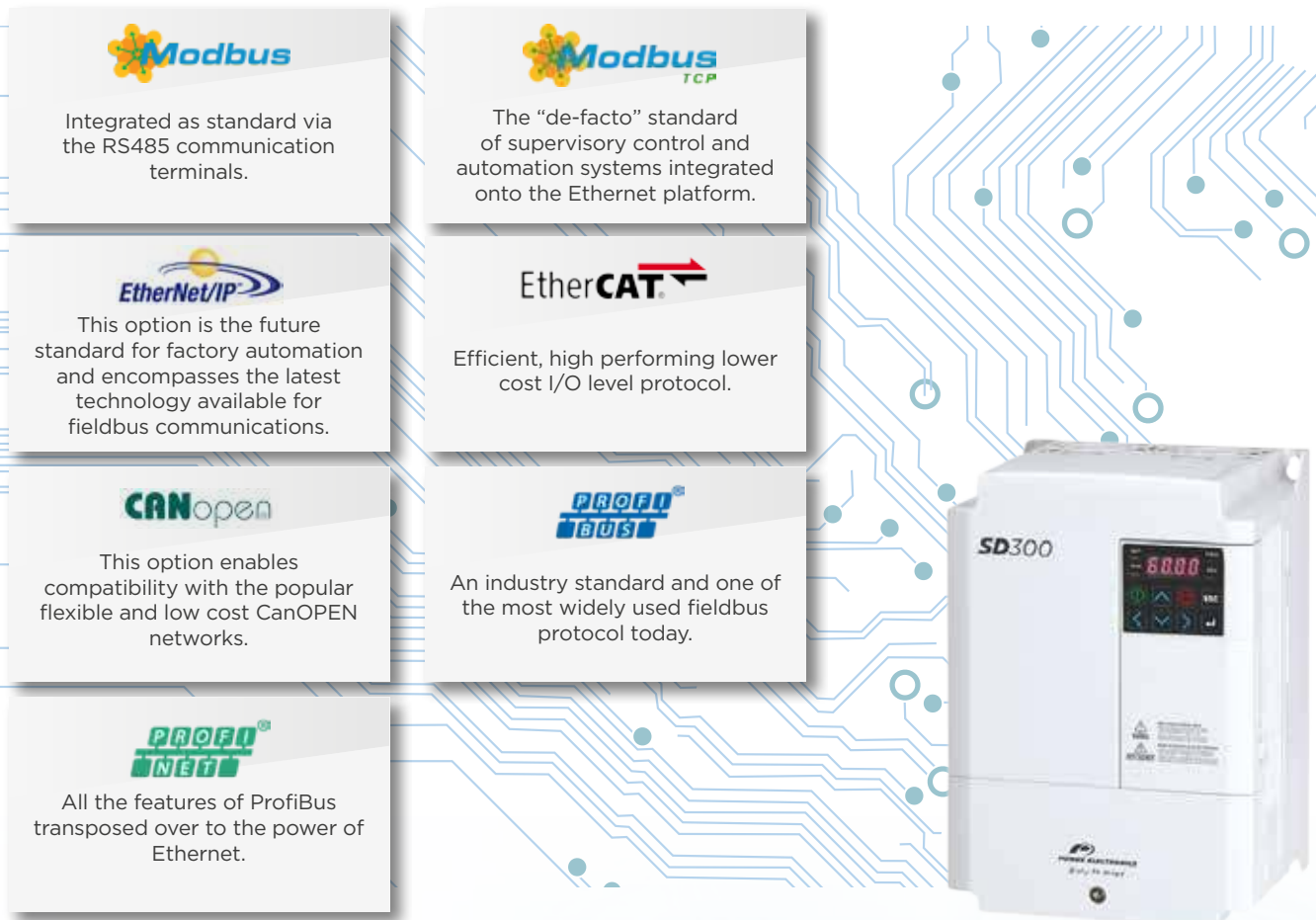

FIELD BUS COMMUNICATIONS

The SD300 integrates the most powerful and widely used fieldbus communication protocols used in automation and industry today. The multiple fieldbus options add another dimension to the versatility of the drive and allow the full potential of the SD300 to be realised as a key component in the automation and control network.



 <p>Integrated as standard via the RS485 communication terminals.</p>	 <p>The “de-facto” standard of supervisory control and automation systems integrated onto the Ethernet platform.</p>
 <p>This option is the future standard for factory automation and encompasses the latest technology available for fieldbus communications.</p>	 <p>Efficient, high performing lower cost I/O level protocol.</p>
 <p>This option enables compatibility with the popular flexible and low cost CanOPEN networks.</p>	 <p>An industry standard and one of the most widely used fieldbus protocol today.</p>
 <p>All the features of ProfiBus transposed over to the power of Ethernet.</p>	

REMOTE DISPLAY

The remote LCD display-keypad option facilitates installation of the drive inside a cabinet while enabling control of the drive by mounting the LCD display-keypad remotely on the cabinet door.

The LCD display-keypad comprises four lines of parameter visualization and programming, parameter upload/download, and local-remote control functionality.



SOFTWARE

The SD300 is packed with new functions to cover all user requirements. Ranging from improved motor control including the integration of PMSM motors to PLC and process and pump control and configurations.

MOTOR CONTROL SENSORLESS AND PMSM

Exceptional performance for asynchronous and synchronous motors.

- Control of asynchronous and synchronous (PMSM) motors.
- Smooth and dynamic control of the motor.
- 200% torque at 0,5Hz.
- Static auto-tuning.
- Fast response to transient load torque changes.
- Improved motor regeneration control.
- Dynamic motor flux control.

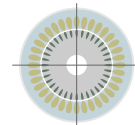

INDUCTION MOTOR (IM)

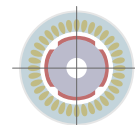

SURFACE PERMANENT MAGNET MOTOR (SPM)

INTERNAL PLC

PLC functions to simplify your external control requirements.

- Simple and powerful functionality.
- Logic operations.
- Arithmetic operations.
- Comparitors.
- Scan rate selection.
- Sequential execution.



ENERGY SAVING FUNCTIONS

Reduces motor power consumption under light load conditions.

- Ideal for variable torque applications.
- Power consumption reduction depending on motor load.
- Reduction of motor losses.
- Automatic and Manual adjustment.

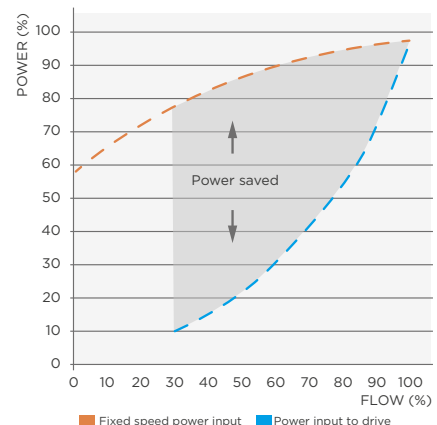

PUMP CONTROL

Smooth and easy control for pumps in simple applications.

- Process PID controller.
- Pre-PID functionality.
- Sleep mode.
- Second PID adjustment.
- Engineering units.





SD300

FOR ALL STANDARD MACHINE AND PROCESS CONTROL NEEDS

*PUMPS, FANS, CONVEYORS, COMPRESSORS,
FOOD & BEVERAGE, MATERIALS HANDLING,
PACKAGING, WOOD PROCESSING, PLASTICS,
AUTOMATIC DOORS...AND ANY GENERAL
PURPOSE MACHINERY*

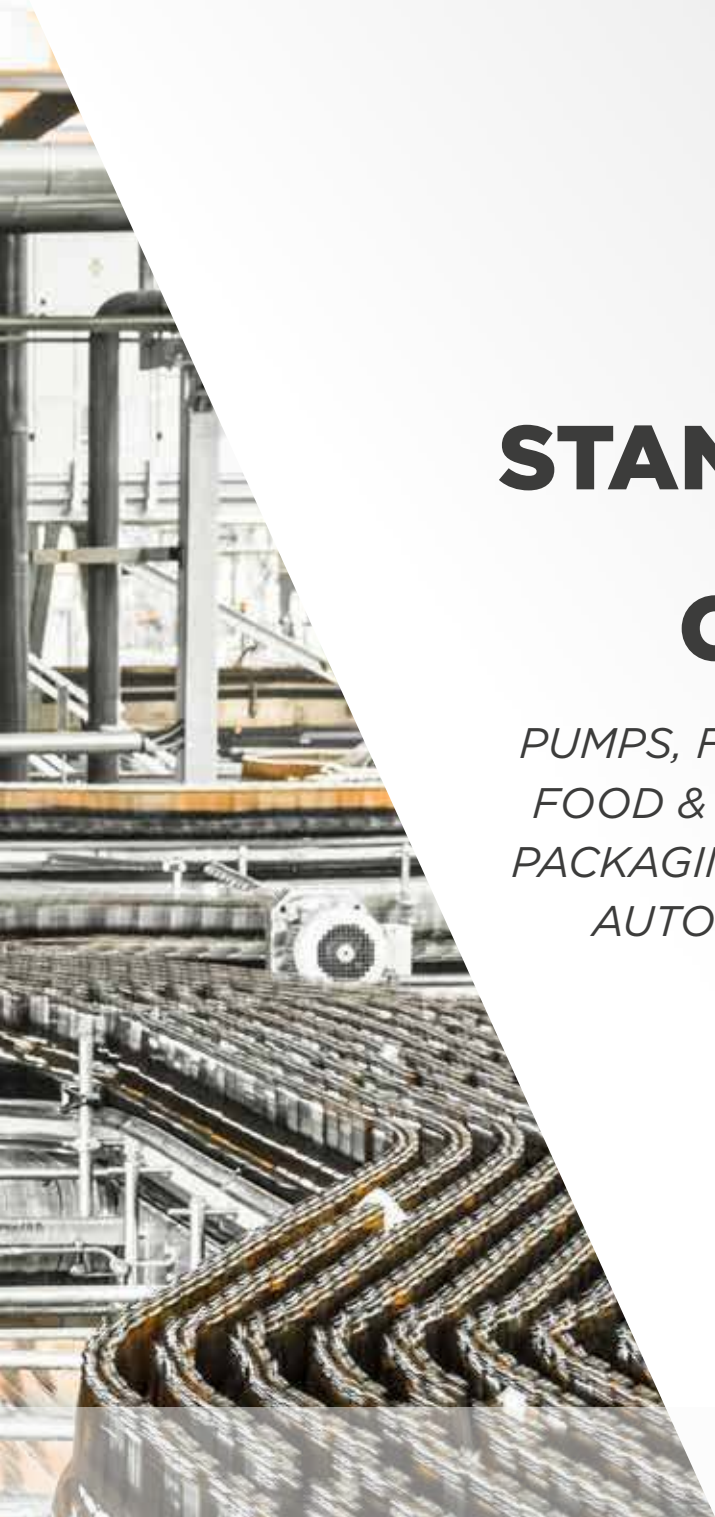

SD300

TECHNICAL CHARACTERISTICS

INPUT	Power ranges	0.4kW - 2.2kW 230V - Single Phase 0.4kW - 22kW 230V - 3-Phase 0.4kW - 30kW 400V - 3-Phase		
	Voltage range	230V: 200-240V Single Phase/3-Phase (-15%/+10%) 400V: 380-480V 3-Phase (-15%/+10%)		
	EMC Filter	C2: 240Vac C3: 240Vac-400Vac		
OUTPUT	Control Method	V/f, Slip compensation, Sensorless vector, PMSM VC ^[1]		
	Frequency Setting Resolution	Digital command: 0.01Hz / Analog command: 0.06Hz (maximum frequency: 60Hz)		
	Frequency Accuracy	1% of the maximum output frequency		
	V/F Pattern	Linear, Quadratic, User V/F		
	Overload Capacity	150% for 60 sec. (Heavy duty) 120% for 60 sec. (Normal duty) ^[2] 200% for 3 sec. (Heavy duty)		
	Output frequency	0-400Hz (Sensorless: 0-120Hz)		
OPERATION	Torque Boost	Manual/Automatic torque boost		
	Operation Mode	Keypad / Terminal / Communication option selectable		
	Frequency Setting	Analog : -10-10V, 0-10V, 4-20mA / Digital : Keypad, Pulse train input		
	Operation Function	PID control, 3-wire operation, Frequency limit, Second function, Anti-forward and reverse direction rotation, Speed search, Power braking, Leakage reduction, Up-down operation, DC braking, Frequency jump, Slip compensation, Automatic restart, Automatic tuning, Energy buffering, Flux braking, Fire Mode		
	Input	Multi-function Terminal IP66 degree: 5 inputs IP20 degree: 7 inputs	NPN (Sink) / PNP (Source) Selectable Function: Forward run, Reverse run, Reset, External trip, Emergency stop, Jog operation, Multi-step frequency-high, middle, low, Multi-step acceleration/ deceleration-high, middle, low, DC braking at stop, 2 nd motor select, Frequency up/down, 3-wire operation, Change into normal operation during PID operation, Change into main body operation during option operation, Analog command frequency fixing, Acceleration/deceleration stop etc. Selectable	
		Analog Input	V1: -10-10V, selectable V2: 0-10V/I2 4-20mA	
		Pulse Train	0-32kHz, Low level: 0-2.5V, High level: 3.5-12V	
	Output	Open Collector Terminal	Fault output and drive	less than DC 24V 50mA
		Multi-function Relay	operation status output	(N.O., N.C.) less than AC 250V 1A, less than DC 30V 1A
		Analog Output	Selectable 0-12Vdc/0-24mA Frequency, Output current, Output voltage, DC bus voltage etc. selectable	
Pulse Train	Maximum 32kHz, 10-12V			
PROTECTIVE FUNCTION	Trip	Over current trip, External signal trip, ARM short circuit current trip, Over heat trip, Ground trip, Motor over heat trip, I/O board link trip, No motor trip, Parameter writing trip, Emergency stop trip, Command loss trip, External memory error, CPU watchdog trip, Motor normal load trip, Over voltage trip, Temperature sensor trip, Drive over heat, Option trip, Output imaging trip, Drive overload trip, Fan trip, Pre-PID operation failure, External break trip, Low voltage trip during operation, Low voltage trip, Safety A(B) trip, Analog input error, Motor overload trip		
	Alarm	Command loss trip alarm, overload alarm, normal load alarm, drive overload alarm, fan operation alarm, resistance braking rate alarm, number of corrections on rotor tuning error		
	Momentary Power Loss	HD below 15ms (ND below 8ms): Continuous operation (To be within rated input voltage, rated output) HD above 15ms (ND above 8ms): Automatic restart operation enable		
ENVIRONMENT	Cooling Type	Forced fan cooling structure		
	Protection Degree	IP20/UL Open (Default), UL Enclosed Type 1 (Option), IP66/NEMA 4X (Option)		
	Ambient Temperature	IP20: HD: -10-50°C(14-122°F) ND: -10-40°C(14-104°F) [However, recommended to use load below 80% when using at 50°C under light load]		
	Storage Temperature	IP66: HD: -10-40°C(14-104°F)		
	Humidity	Relative humidity below 90% RH (non condensing)		
	Altitude, Vibration	Below 1000m, below 9.8m/sec ² (1G)		
	Location	No corrosive gas, flammable gas, oil mist and dust etc. indoors (Pollution Degree 3 Env.)		
REGULATIONS	Pressure	70-106 kPa		
	Global certification	CE, UL, cUL, RoHS		
	PCB	3C2 Conformal coating		

NOTES [1] Please consult Power Electronics before the installation with these kind of motors.

[2] Only available with IP20 protection degree.

INPUT/OUTPUT TERMINATIONS

Connection external DC reactor
Harmonic mitigation

Integrated dynamic brake switch

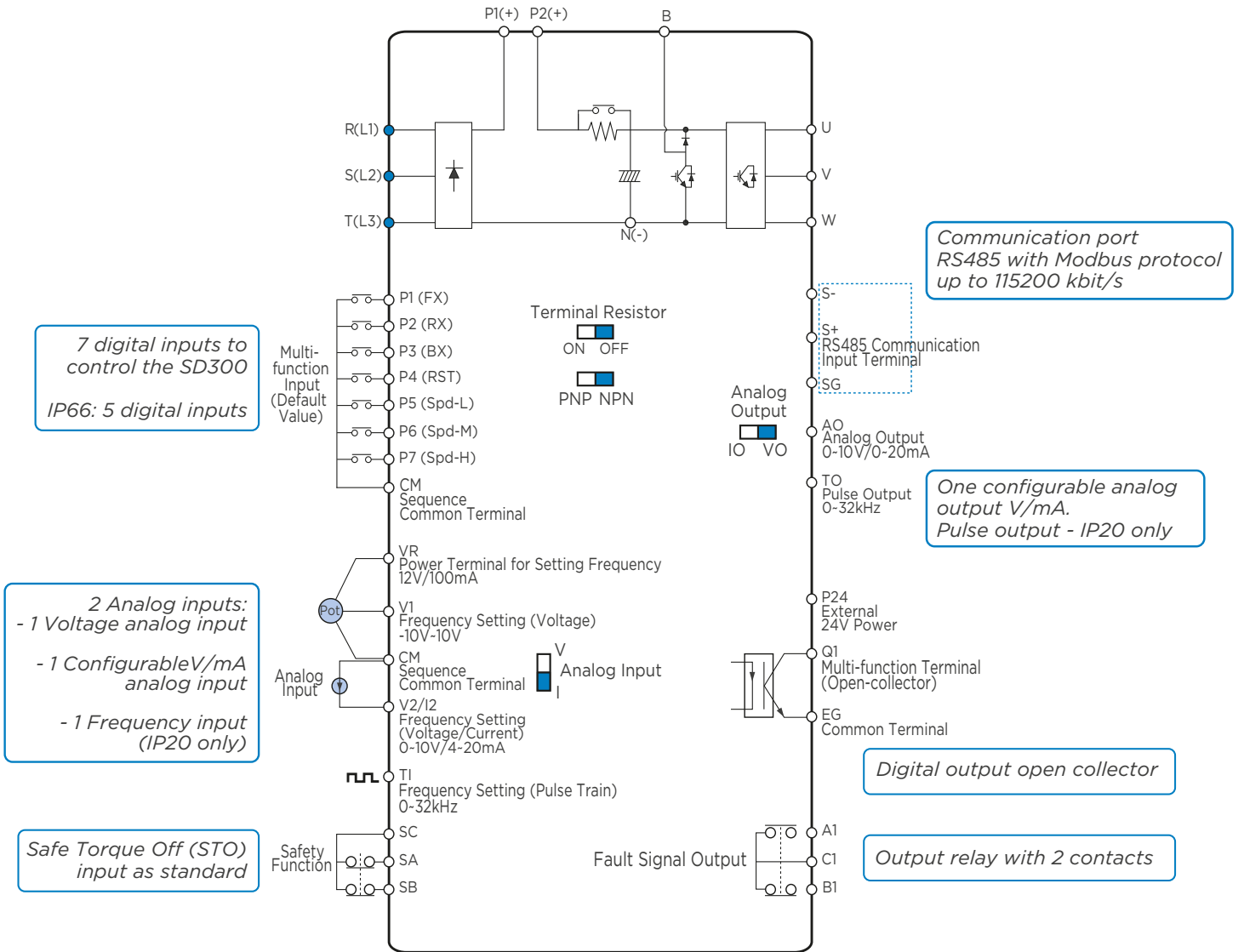

7 digital inputs to control the SD300
IP66: 5 digital inputs

2 Analog inputs:
- 1 Voltage analog input
- 1 Configurable V/mA analog input
- 1 Frequency input (IP20 only)

Safe Torque Off (STO) input as standard

Communication port RS485 with Modbus protocol up to 115200 kbit/s

One configurable analog output V/mA. Pulse output - IP20 only

Digital output open collector

Output relay with 2 contacts

SD300

FRAMES

IP20

FRAME 1N



FRONT

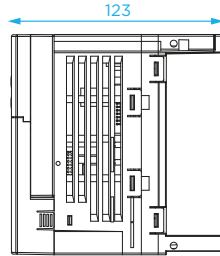

SIDE

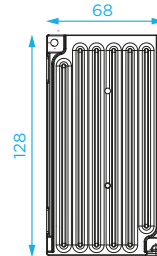

BACK



BOTTOM

FRAME 2N



FRONT

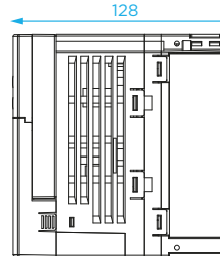

SIDE

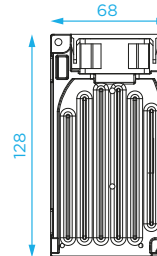

BACK



BOTTOM

FRAME 3N

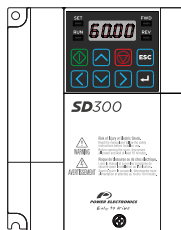

FRONT

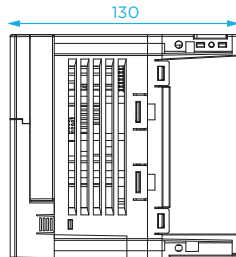

SIDE

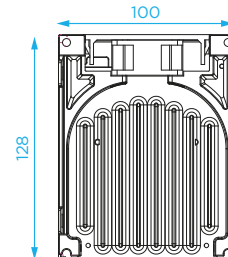

BACK

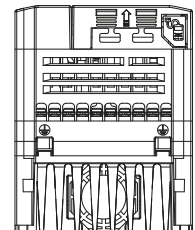

BOTTOM

FRAME 4N

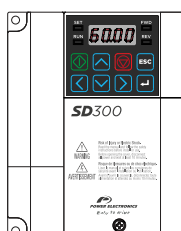

FRONT

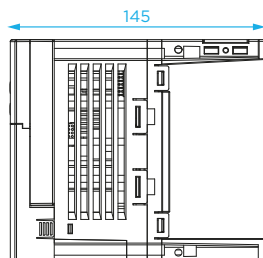

SIDE

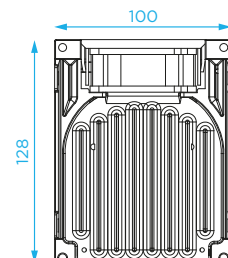

BACK

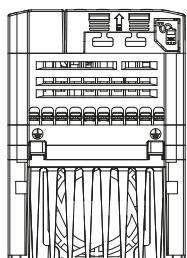

BOTTOM

FRAME 5N

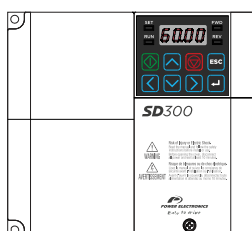

FRONT

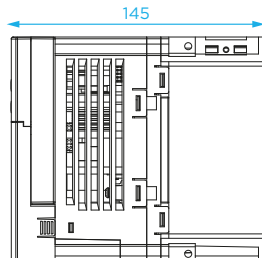

SIDE

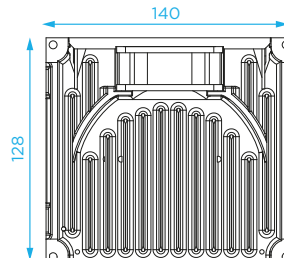

BACK

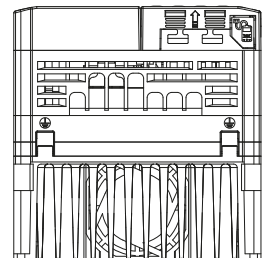

BOTTOM

IP20

FRAME 1F



FRONT

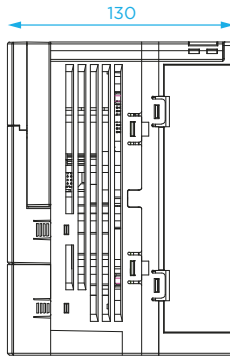

SIDE

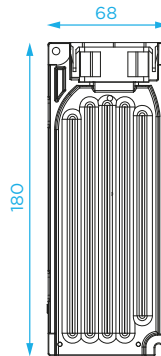

BACK

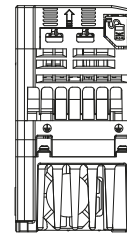

BOTTOM

FRAME 2F

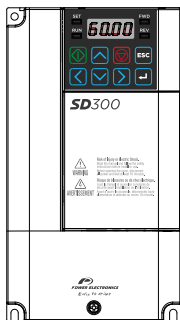

FRONT

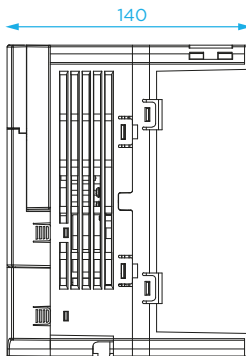

SIDE

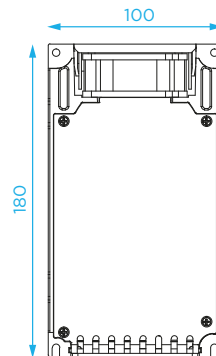

BACK

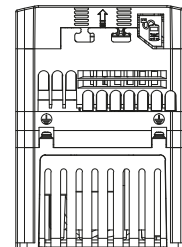

BOTTOM

FRAME 3F

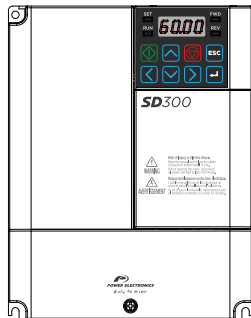

FRONT

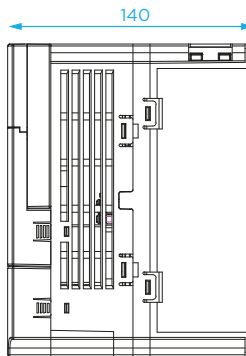

SIDE

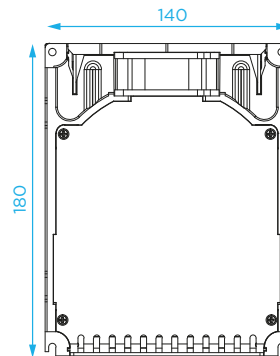

BACK

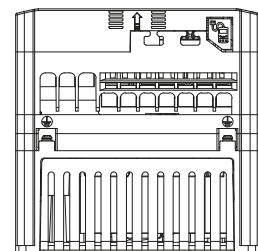

BOTTOM

SD300

FRAMES

IP20

FRAME 4

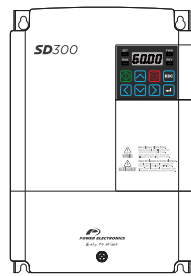

FRONT

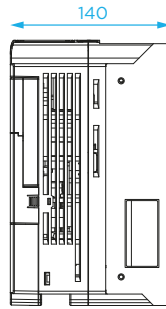

SIDE

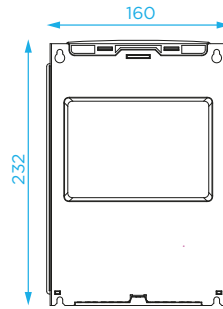

BACK

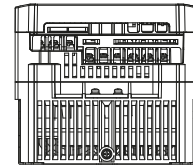

BOTTOM

FRAME 5

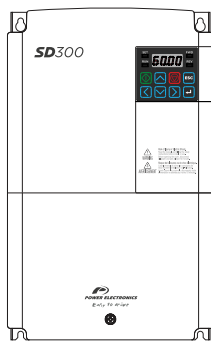

FRONT

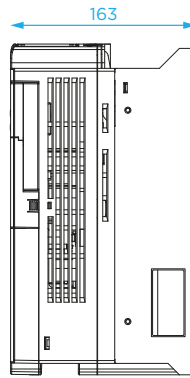

SIDE

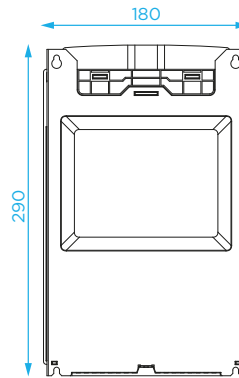

BACK

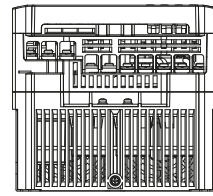

BOTTOM

FRAME 6

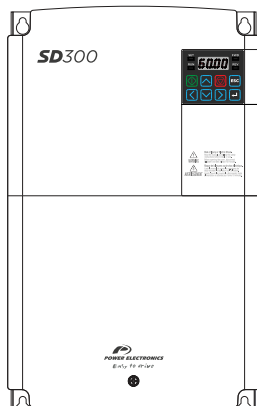

FRONT

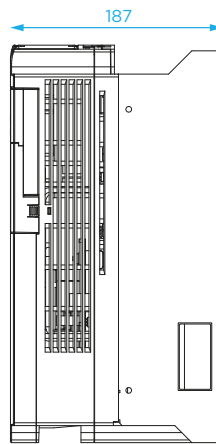

SIDE

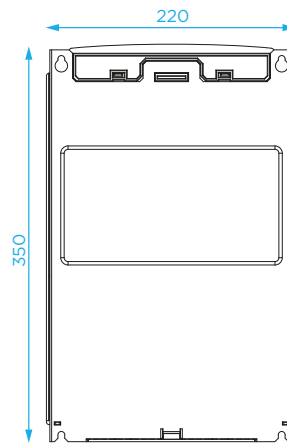

BACK

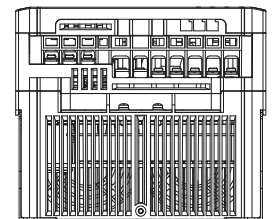

BOTTOM

IP66 - NEMA 4X

FRAME 1I

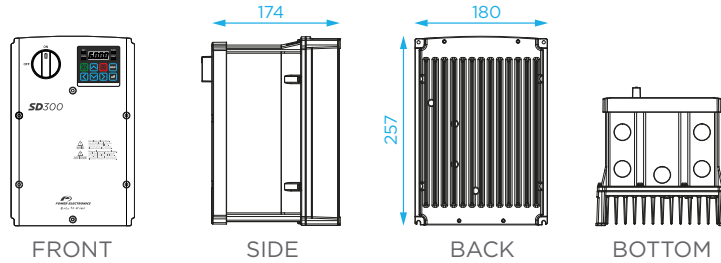

FRAME 2I

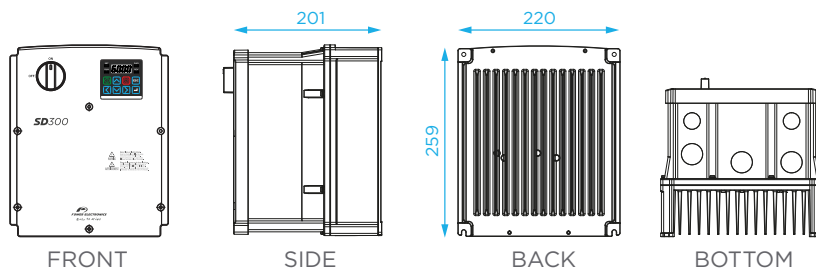

FRAME 3I

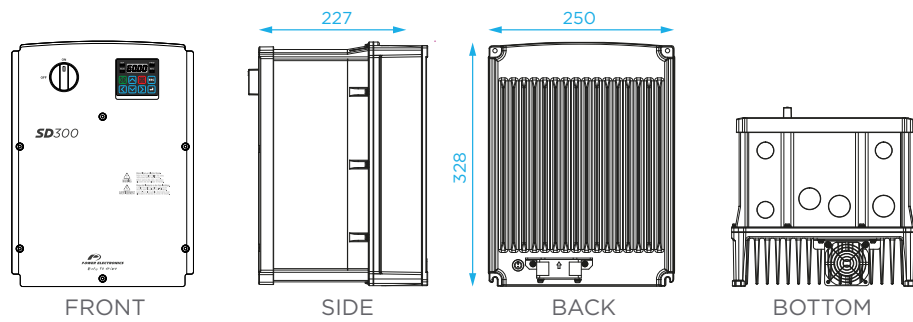

FRAME 4I

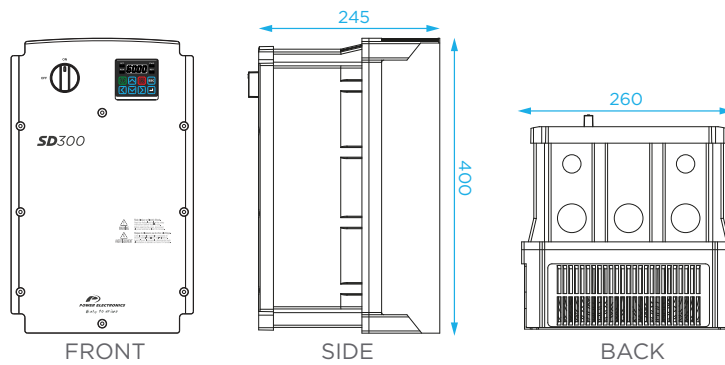

FRAME 5I

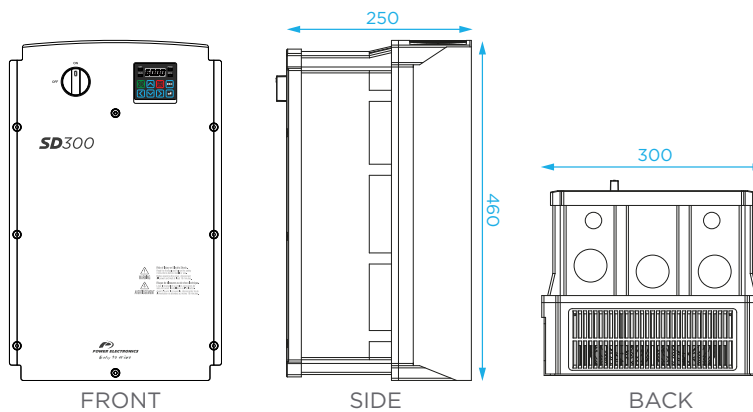

SD300

CONFIGURATION TABLE & STANDARD RATINGS

SD3	058		04		20		EMC Filter	
SD300 SERIES	Current normal duty*		Voltage		Degree of protection		EMC Filter	
SD3	002	2A	1	230Vac Single Phase	2	IP20	F	Extended
	...		2	230Vac Three Phase	6	IP66	-	Standard
	069	69A	4	400Vac Three Phase				

*Heavy duty for IP66 models.

230VAC SINGLE PHASE

230VAC SINGLE PHASE - IP20															
Power ND (kW)	Current ND (A)	Power HD (kW)	Current HD (A)	EMC STANDARD					EMC EXTENDED						
				MODEL	WEIGHT (kg)	DIMENSIONS (mm)			FRAME	MODEL	WEIGHT (kg)	DIMENSIONS (mm)			FRAME
						W	H	D				W	H	D	
0,75	3.1	0,4	2.5	SD300312	0.88	68	128	128	2N	SD300312F ^[1]	1.1	68	180	130	1F
1,5	6.0	0,75	5.0	SD300612	1.3	100	128	130	3N	SD300612F ^[1]	1.8	100	180	140	2F
2,2	9.6	1,5	8.0	SD300912	1.5	100	128	145	4N	SD300912F ^[1]					
3,7	12.0	2,2	11.0	SD301212	2.2	140	128	145	5N	SD301212F ^[1]	2.2	140	180	140	3F

[1] Class 2

230VAC THREE PHASE

230VAC THREE PHASE - IP20										
Power ND (kW)	Current ND (A)	Power HD (kW)	Current HD (A)	MODEL	WEIGHT (kg)	DIMENSIONS (mm)			FRAME	
						W	H	D		
0,75	3.1	0,4	2.5	SD300322	0.86	68	128	123	1N	
1,5	6.0	0,75	5.0	SD300622	0.86	68	128	128	2N	
2,2	9.6	1,5	8.0	SD300922	1.5	100	128	130	3N	
4	12	2,2	11	SD301222	1.5	100	128	145	4N	
5,5	18	4	17	SD301822	2.3	140	128	145	5N	
7,5	30	5,5	24	SD303022	3.3	160	232	140	4	
11	40	7,5	32	SD304022						
15	56	11	46	SD305622	4.6	180	290	163	5	
22	69	15	60	SD306922	5.5	220	350	187	6	

230VAC THREE PHASE - IP66 (only Heavy Duty)									
Power HD (kW)	Current HD (A)	MODEL	WEIGHT (kg)	DIMENSIONS (mm)			FRAME		
				W	H	D			
0,4	2.5	SD300326	3.6	180	257	174	11		
0,75	5.0	SD300526							
1,5	8.0	SD300826	5.2	220	259	201	21		
2,2	11	SD301126							
4	17	SD301726							
5,5	24	SD302426	11.7	250	328	227	31		
7,5	32	SD303226							
11	46	SD304626	12.6	260	400	245	41		
15	60	SD306026	15.3	300	460	250	51		

400VAC THREE PHASE

400VAC THREE PHASE - IP20									
Power ND (kW)	Current ND (A)	Power HD (kW)	Current HD (A)	MODEL	WEIGHT (kg)	DIMENSIONS (mm)			FRAME
						W	H	D	
0,75	2.0	0,4	1.3	SD300242	0.86	68	128	123	1N
1,5	3.1	0,75	2.4	SD300342	0.88	68	128	128	2N
2,2	5.1	1,5	4.0	SD300542	1.5	100	128	130	3N
4	6.9	2,2	5.5	SD300742	1.5	100	128	145	4N
5,5	10	4	9.0	SD301042	2.7	140	128	145	5N

400VAC THREE PHASE - IP20 - EMC EXTENDED									
Power ND (kW)	Current ND (A)	Power HD (kW)	Current HD (A)	MODEL	WEIGHT (kg)	DIMENSIONS (mm)			FRAME
						W	H	D	
0,75	2.0	0,4	1.3	SD300242F ^[2]	1.1	68	180	130	1F
1,5	3.1	0,75	2.4	SD300342F ^[2]	1.2				
2,2	5.1	1,5	4.0	SD300542F ^[2]	1.8	100	180	140	2F
4	6.9	2,2	5.5	SD300742F ^[2]					
5,5	10	4	9.0	SD301042F ^[2]	2.9	140	180	140	3F
7,5	16	5,5	12	SD301642F ^[2]	3.4	160	232	140	4
11	23	7,5	16	SD302342F ^[2]					
15	30	11	24	SD303042F ^[2]	4.8	180	290	163	5
18,5	38	15	30	SD303842F ^[2]					
22	44	18,5	39	SD304442F ^[2]	7.5	220	350	187	6
30	58	22	45	SD305842F ^[2]					

[2] Class 3

400VAC THREE PHASE - IP66 (only Heavy Duty)									
Power HD (kW)	Current HD (A)	EMC STANDARD		EMC EXTENDED		DIMENSIONS (mm)			FRAME
		MODEL	WEIGHT (kg)	MODEL	WEIGHT (kg)	W	H	D	
0,4	1.3	SD300146	3.6	SD300146F ^[2]	3.7	180	257	174	1I
0,75	2.4	SD300246	3.6	SD300246F ^[2]	3.7				
1,5	4.0	SD300446	5.1	SD300446F ^[2]	5.3	220	259	201	2I
2,2	5.5	SD300646	5.3	SD300646F ^[2]	5.5				
4	9.0	SD300946	5.3	SD300946F ^[2]	5.6	250	328	227	3I
5,5	12	SD301246	8.3	SD301246F ^[2]	8.8				
7,5	16	SD301646	8.5	SD301646F ^[2]	8.9	260	400	245	4I
11	24	SD302446	9.2	SD302446F ^[2]	9.6				
15	30	SD303046	9.4	SD303046F ^[2]	9.8	300	460	250	5I
18,5	39	SD303946	12	SD303946F ^[2]	12.4				
22	45	SD304546	12	SD304546F ^[2]	12.4				

[2] Class 3

SD300

ACCESSORIES



• MULTIPLE FIELDBUS OPTIONS EASY TO INSTALL AND USE

- PROFINET
- Modbus TCP
- CANopen
- Profibus-DP
- EtherCAT
- Ethernet IP



• CONDUIT KIT

UL open type and enclosed type 1 certification:

- UL open type is offered as default.
- UL enclosed type1 needs conduit kit (option) installation.



• FLANGE TYPE

The heat sink can be mounted outside the panel in case of space limitations.

• I/O EXPANSION CARD OPTION

- 2 Relay outputs
- 3 Digital inputs
- 2 Analog Inputs
- 1 Analog Output

SD300 - ACCESSORIES REFERENCES

REFERENCE	DESCRIPTION
SD3CO	CANOpen communication module
SD3PB	Profibus communication module
SD3ETH	Ethernet I/P - Modbus TCP communication module
SD3ETC	EtherCAT communications module
SD3PN	Profinet communications module
SD3IO	Expansion module I/O
SD3EBF1	Conduit module frame 1N and 2N for NEMA1 compliant
SD3EBF2	Conduit module frame 3N and 4N for NEMA1 compliant
SD3EBF3	Conduit module frame 5N for NEMA1 compliant
SD3EBIP6F1	Conduit module frame 1F for NEMA1 compliant
SD3EBIP6F2	Conduit module frame 2F for NEMA1 compliant
SD3EBIP6F3	Conduit module frame 3F for NEMA1 compliant
SD3EBF4	Conduit module frame 4 for NEMA1 compliant
SD3EBF5	Conduit module frame 5 for NEMA1 compliant
SD3EBF6	Conduit module frame 6 for NEMA1 compliant
SD3FLGF1	Flange module frame 1N and 2N
SD3FLGF2	Flange module frame 3N and 4N
SD3FLGF3	Flange module frame 5N
SD3FLGIP6F1	Flange module frame 1F
SD3FLGIP6F2	Flange module frame 2F
SD3FLGIP6F3	Flange module frame 3F
SD3FLGF4	Flange module frame 4
SD3FLGF5	Flange module frame 5
SD3FLGF6	Flange module frame 6
SD3CF1	Remote display-keypad option

SD100

VARIABLE SPEED DRIVES



SD100

The SD100 variable speed drives is the smallest of the family, the only one that is able to drive three-phase motors with single-phase power supply, thus avoiding the costs associated with new lines.

Manufactured in two sizes, the SD100 series covers a power range from 0.4 to 2.2kW. It has an IP20 degree of protection suitable for installing multiple units inside compact cabinets.

Its small size, high performance and intuitive control bring out the advantages of speed control to a wide range of applications such as irrigation, drink water pumps, elevators, parking barriers, automatic doors and ventilations systems.

SUITABLE FOR LOW POWER
SINGLE PHASE APPLICATIONS

- RANGING FROM 0.4KW TO 2.2KW, 200-230V SINGLE PHASE POWER SUPPLY
- EASY PROGRAMMING AND INTUITIVE OPERATION THROUGH JOYSTICK
- DRIVE THREE-PHASE MOTORS WITH SINGLE-PHASE SUPPLY
- SELECTABLE DIGITAL INPUT POLARITY (NPN, PNP)
- RFI FILTER AND OPTIONAL MODBUS RTU COMMUNICATIONS
- 3 YEAR WARRANTY AND 24H SERVICE AND REPLACEMENT COMMITMENT

COMPETITIVE

Compact and competitive equipment for multiple applications.

INTUITIVE AND USER FRIENDLY OPERATION

The joystick allows the user to adjust the configuration parameters easily. The units are delivered with pre-set factory settings ready for quick commissioning.



EASY INSTALATION

Two holes allow the user to screw the unit to a panel mounted in your cabinet. The rear cooling fans can be easily removed from the bottom, a book type design allows the user to install drives side by side saving space, and the front connections reduce wiring complexity.

MULTIPLE I/O

Featured with 1 analogue input, 5 digital inputs, 1 analogue output, 1 digital output and 1 output relay that can be easily programmed to be connected to pressure transducers, level sensors, flow meters, PLCs or external controllers. The digital signals can be easily shifted from NPN to PNP mode with a selector.



DISPLAY	
FWD	Lit during forward run
REV	Lit during reverse run
LEDS	Display operation status and parameter information

KEYPAD		
RUN	Run command	
STOP/RST	STOP: Drive stops; RST: Faults reset	
JOYSTICK	▲	Screen scrolling
	▼	Screen scrolling
	◀	Parameters scrolling
	▶	Parameters scrolling
	●	Confirmation and enter
POTENTIOMETER	Load frequency control	

APPLICATIONS

Power Electronics' SD100 series is designed for single phase applications. Due to its simple operation and compact size is perfect for reduced spaces allowing the integration of multiple units in the same cubicle. Its features cover a wide

range of applications in motion drives and HVAC. Treadmills, automatic gates, irrigation pumps, clean water pumps, ornamental fountains and others are a small sample of what you can do with this small and competitive drive.



SD100

TECHNICAL CHARACTERISTICS

INPUT	Power range	0,4kW - 2,2kW
	Voltage power	200 to 230Vca ($\pm 10\%$) Monophase
	Input frequency	50-60Hz ($\pm 5\%$)
	Input power factor	> 0.98% (over fundamental frequency)
	Input RFI filter	Class 2 (optional)
OUTPUT	Motor output voltage	200Vac - 230Vac, Three phase
	Overload capacity	150% during 60 sec. 200% during 30 sec.
	Frequency ratings	0 to ± 400 Hz
	Efficiency (full load)	>98%
	Modulation method	Vector space modulation
	Modulation frequency	Maximum 15kHz
	Output cable length	USC 50m, SC 25m ^[1]
	Control Method	V/Hz control, Vector control (Sensorless)
ENVIRONMENTAL CONDITIONS	Operation method	PID Control. Potentiometer and 3 wires control
	Degree of protection	IP20
	Operation temperature	-10°C to +50°C
	Storage temperature	-20°C to +65°C
	Relative humidity	<90%, non-condensing
	Altitude	1000m
	Power altitude derating (> 1000m)	(>1000m)-1% per 100m; maximum 3000m
PROTECTIONS	Vibration	Máx. 5.9m/sec ² (= 0.6G)
	Drive trip	Over-voltage, Under-voltage, Over-current, Ground fault current detection, Over-temperature of inverter and motor, Output phase open, Overload, Communication error, Loss of frequency command, Hardware fault
INPUTS/OUTPUTS	Alarm condition	Stall prevention, Overload
	Analogue inputs	1 input 0-10Vdc / 1 0-20mA
	Digital inputs	5 configurable inputs
	Analogue outputs	1 output 0-10 Vdc
	Digital outputs	1 multifunction output (open collector), max. 24Vdc/50mA
COMMUNICATIONS	Relay output	1 multifunction relay 2A 30Vdc, 0.5A 125Vac
	Protocol (optional)	Modbus-RTU, RS485
REGULATIONS		CE, cTick, UL ^[2] , cUL ^[2]

NOTES [1] For more detailed specifications,consultar con Power Electronics.
[2] On process.

SD100 - DIMENSIONS



SD100 - ACCESSORIES

CODE	ACCESSORIES DESCRIPTION
SD1TCM	Modbus-RTU board

SD100 - CONTROL AND POWER WIRING

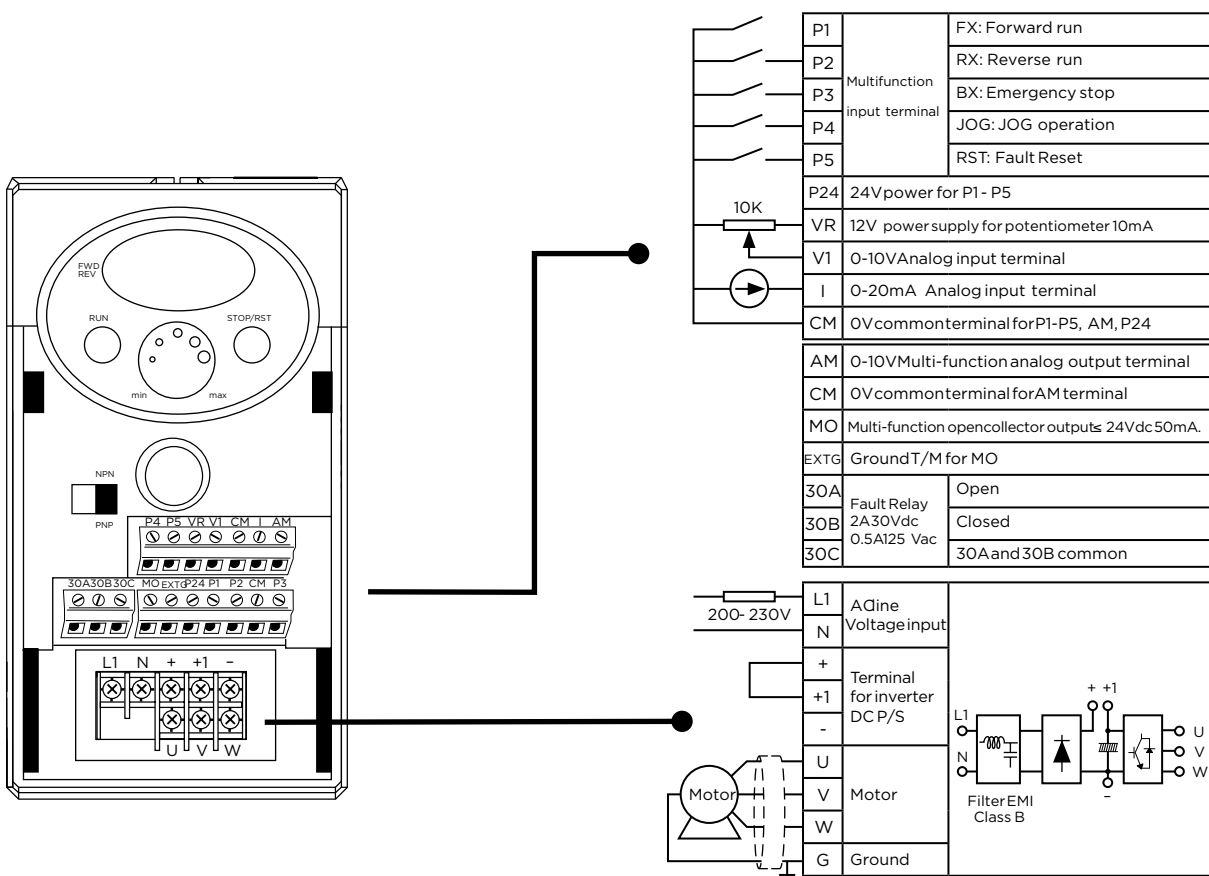

SD100 - STANDARD RATINGS AND WEIGHTS

200Vac - 230Vac ($\pm 10\%$)							
Frame	Code	I(A) Rated	Power (kW)	Power (HP)	Voltage Supply	Weight (Kg)	Filter
1	SD1103	3	0.4	0.5	230 II	0.87	NO
	SD1103F	3	0.4	0.5	230 II	0.95	YES
	SD1105	5	0.75	1	230 II	0.89	NO
	SD1105F	5	0.75	1	230 II	0.97	YES
2	SD1108	8	1.5	2	230 II	1.79	NO
	SD1108F	8	1.5	2	230 II	1.94	YES
	SD1112	12	2	3	230 II	1.85	NO
	SD1112F	12	2	3	230 II	2	YES

Warranty

Power Electronics (the Seller) warrants that their INDUSTRIAL Products are free of faults and defects for a period of 3 years, valid from the date of delivery to the Buyer. It shall be understood that a product is free of faults and defects when its condition and performance is in compliance with its specification.



The warranty shall not extend to any Products whose defects are due to (i) careless or improper use, (ii) failure to observe the Seller's instructions regarding the transport, installation, functioning, maintenance and the storage of the Products, (iii) repairs or modifications made by the Buyer or third party without prior written authorization of the Seller, (iv) negligence during the implementation of authorized repairs or modifications, (v) if serial numbers are modified or illegible, (vi) anomalies caused by, or connected to, the elements coupled directly by the Buyer or by the final customer, (vii) accidents or events that place the Product outside its storage and operational specification, (viii) continued use of the Products after identification of a fault or defect.

The warranty excludes components that must be replaced periodically such as fuses, lamps & air filters or consumable materials subject to normal wear and tear.

The warranty excludes external parts that are not manufactured by the Seller under the brand of Power Electronics.

The Seller undertakes to replace or to repair, himself, at their discretion, any Product or its part that demonstrates a fault or defect, which is in conformance with the aforementioned terms of the warranty. Reasonable costs associated with the disassembly/assembly, transport and customs of equipment will also be undertaken by the Seller except in cases of approved intervention by the Buyer and/or their representative where cost allocation has been previously agreed.

In case of fault or defect, the Buyer shall notify the Seller in writing by using the following contact email: quality@power-electronics.com, of the presence of any fault or defect within 15 days of the fault or defect event. The serial number of the defective product plus a brief description of the fault must be included in the email. Failure to notify the Seller of fault or defect within this time period may result in the warranty becoming invalid.

In the event of replacement of defective Product or part thereof, the property of the Product or part shall be transferred to the Seller.

The Seller shall bear no liability for damages to property or third persons, even as manufacturer of the Products, other than that expressly provided by virtue of applicable mandatory law provisions. In any case, the Seller shall not be liable for indirect or consequential damages of whatsoever nature as, by way of example, production losses or unearned profits.

The Seller shall, at their discretion, forfeit all warranty rights of the Buyer if the total sum of the contract and payment has not been reached in accordance with the agreed conditions of the contract.

No other warranties, express or implied, are made with respect to the Products including, but not limited to, any implied warranty of merchantability or fitness for a particular purpose. In any case, the Buyer's right to damages shall be limited to a maximum amount equal to no more than the price obtained by the Seller of the faulty or defective Products.

These conditions shall apply to any repaired or replacement products. Notwithstanding the above, the replacement of a Product does not imply an extension of the term of warranty outside that of the original term.

Contact

24H/7D TECHNICAL ASSISTANCE	HEADQUARTERS - VALENCIA - SPAIN
	C/ Leonardo da Vinci, 24 - 26 - Parque Tecnológico - 46980 - PATERNA - VALENCIA - SPAIN Tel. 902 40 20 70 - Tel. (+34) 96 136 65 57 - Fax (+34) 96 131 82 01
	INTERNATIONAL SUBSIDIARIES
AUSTRALIA	Power Electronics Australia Pty Ltd - Unit 4, 1378 Lytton Road, Hemmant Qld 4174 - Brisbane Tel. (+61) 7 3386 1993 • Email: sales@power-electronics.com.au
BRAZIL	P.E. Brazil Ltda - Domo Business - Rua José Versolato, 111 - Conjunto 1509 - Torre B - Centro São Bernardo do Campo - SP - Brasil CEP 09750-730 Tel. (+55) 11 5891 9612 - Tel. (+55) 11 5891 9762 Email: comercialbrasil@power-electronics.com
CHILE	Alonso de Córdova nº 5870, Oficina 210-211 - Las Condes - Santiago de Chile Tel. (+56) 2 3223 8916 - Email: ventas@pech.cl
CHINA	<ul style="list-style-type: none"> • Power Electronics Beijing - Room 606, Yiheng Building - No 28 East Road, Beisanhuan - 100013, Chaoyang District, BEIJING - R.P. CHINA - Tel. (+86 10) 6437 9197 - Fax (+86 10) 6437 9181 • Power Electronics Asia Ltd - 20/F Winbase Centre - 208 Queen's Road Central - Hong Kong Email: sales@power-electronics.com.cn
COLOMBIA	Terminal Terrestre de Carga, Autopista vía Medellín, km. 3.5 Costado Sur, Bodega 60, Sector Cota. Mobile +57 322 3464855, PBX +57 1 8985278
FRANCE	Power Electronics France SARL - Bibliothèque Nationale 2 - 104 Avenue de France - 75013 Paris, France Telf. +33(0)1 46 46 10 34 Ext. 1034 Email: ventesfrance@power-electronics.com
GERMANY	Power Electronics Solar GmbH - DNeuseser Strasse 15 - 90455 Nürnberg Tel. (+49) 911 99 43 99 0 - Fax (+49) 911 99 43 99 8 • Email: info@ped-deutschland.de
INDIA	Power Electronics India - N°5, Cunningham Crescent, 1 st floor. Bangalore- 560052 Tel./Fax : +91 80 6569 0489 • Email: salesindia@power-electronics.com
ITALY	Power Electronics Italia Srl. - Centro Direzionale Colleoni - Via Paracelso 16 - 20864 Agrate Brianza - Monza Tel. (+39) 039 9050899 • Email: infoitalia@power-electronics.com
JAPAN	Power Electronics Japan KK - 2-7-5, Toranomom, Minato-ku, Tokyo, Japan 105-0001 Burex Toranomom Building 3 rd Floor Tel. 03-6206-1145 • Fax 03-6206-1175 • Email: salesjapan@power-electronics.com
KOREA	P.E. Asia HQ Co - Room #305, SK Hub Primo Building - 953-1 Dokok-dong, Gangnam-gu - 135-270 - Seoul Tel. (+82) 2 3462 4656 - Fax (+82) 2 3462 4657 • Email: sales@power-electronics.kr
MEXICO	P. E. Internacional Mexico S de RL - Calz. Jinetes #197 - Las Arboledas Atizapan de Zaragoza - 52950, Mexico Tel. (+52) 55 5390 8818 • Tel. (+52) 55 5390 8363 • Email: ventasmexico@power-electronics.com
MOROCCO	Power Electronics - Ekoakua • Geea sarl , N°184 Bloc Hay EL.Massira Aït Melloul •CP 80150 • Agadir Tel: + 212 5 28 24 04 57 • Mob: (+34) 628 11 76 72 • Email: ventesmaroc@power-electronics.com
NEW ZEALAND	P.E. New Zealand Ltd - 14B Opawa Road, Waltham - Christchurch 8023 P.O. Box 1269 Christchurch 8140 Tel. (+64 3) 379 98 26 - Fax.(+64 3) 379 98 27 • Email: sales@power-electronics.co.nz
SOUTH AFRICA	Power Electronics South Africa Pty Ltd · Central Office Park Unit 5 · 257 Jean Avenue · Centurion 0157 Tel. (+34) 96 136 65 57 · Fax (+34) 96 131 82 01 • Email: salesza@power-electronics.com
SWEDEN	Stora Varvsgatan 13a, 211 75 Malmö Tel. 040-35 86 00 Fax 040-93 23 01 • Email: swedensales@power-electronics.com
TURKEY	Şerifali Mah. Edep Sok. No:30 Ümraniye • Istanbul Tel: 0 216 824 00 00 Pbx · Fax: 0 216 824 01 01 • Email: turkiyesatis@power-electronics.com
UAE	Power Electronics España S.L. DMCC Branch - P.O. Box 487282, 33 rd Floor, HDS Business Centre, Plot M1 Jumeirah Lakes Tower, Dubai, U.A.E. - Tel. +971 4 364 1200 Email: middleeast@power-electronics.com
UNITED KINGDOM	Power Electronics UK Pty Ltd · Wells House, 80 Upper Street, Islington · London, N1 ONU · 147080 Islington 5 Tel. (+44) 149 437 00 29 • Email: uksales@power-electronics.com
UNITED STATES	Power Electronics USA Inc. • 4777 N 44 th Ave • Phoenix, Arizona 85031 Tel. 602-354-4890 • Email: sales@power-electronics.us





www.power-electronics.com